

Diaphragm Sealed
Differential Pressure and
Pressure Transmitters
EJ□118□ and EJ□438□

IM 01C25H01-01E



Diaphragm Sealed Differential Pressure and Pressure Transmitters

EJ□118□ and EJ□438□

IM 01C25H01-01E 15th Edition

Contents

1.	Introduction.....	1-1
	■ Regarding This Manual.....	1-2
	■ Trademarks	1-2
	1.1 Safe Use of This Product	1-3
	1.2 Warranty.....	1-5
2.	Handling Cautions.....	2-1
	2.1 Model and Specifications Check.....	2-1
	2.2 Unpacking.....	2-1
	2.3 Storage	2-1
	2.4 Selecting the Installation Location	2-2
	2.5 Pressure Connection.....	2-2
	2.6 Waterproofing of Cable Conduit Connections	2-2
	2.7 Restrictions on Use of Radio Transceivers	2-3
	2.8 Insulation Resistance and Dielectric Strength Test.....	2-3
	2.9 Installation of an Explosion-Protected Instrument.....	2-4
	2.9.1 FM Approval.....	2-4
	2.9.2 CSA Certification.....	2-6
	2.9.3 ATEX Certification.....	2-9
	2.9.4 IECEx Certification.....	2-13
	2.10 EMC Conformity Standards.....	2-16
	2.11 Pressure Equipment Directive (PED)	2-16
	2.12 EU RoHS Directive	2-17
	2.13 Safety Requirement Standards	2-17
3.	Component Names	3-1
4.	Installation.....	4-1
	4.1 Precautions	4-1
	4.2 Mounting the Diaphragm Seals.....	4-1
	4.3 Transmitter Mounting	4-2
	4.4 Mounting the Flushing Connection Ring.....	4-4
	4.4.1 Mounting to Pressure Detector Section.....	4-4
	4.4.2 Mounting to Process Flange	4-4

4.5	Affixing the Teflon Film	4-5
4.6	Rotating Transmitter Section	4-5
4.7	Changing Integral Indicator Direction	4-6
5.	Wiring	5-1
5.1	Wiring Precautions	5-1
5.2	Selecting the Wiring Materials	5-1
5.3	Connections of External Wiring to Terminal Box	5-1
5.3.1	Power Supply Wiring Connection	5-2
5.3.2	External Indicator Connection.....	5-2
5.3.3	Communicator Connection	5-2
5.3.4	Check Meter Connection	5-3
5.3.5	Status Output Connection.....	5-3
5.4	Wiring	5-3
5.4.1	Loop Configuration	5-3
5.4.2	Wiring Installation.....	5-4
5.5	Grounding	5-5
5.6	Power Supply Voltage and Load Resistance	5-5
6.	Operation	6-1
6.1	Preparation for Starting Operation	6-1
6.2	Zero Point Adjustment	6-3
6.3	Starting Operation	6-4
6.4	Shutting Down Operation	6-4
6.5	Venting or Draining Transmitter Process-Detector Section	6-5
6.5.1	Draining Condensate for Flushing Connection Ring	6-5
6.5.2	Venting Gas for Flushing Connection Ring.....	6-5
6.6	Local Parameter Setting	6-6
6.6.1	Local Parameter Setting (LPS) Overview.....	6-6
6.6.2	Activating Local Parameter Setting	6-8
6.6.3	Parameter Setting Review	6-8
6.6.4	Loop Test Configuration	6-9
6.6.5	Tag Number Configuration.....	6-9
6.6.6	Pressure Unit Configuration.....	6-9
6.6.7	Pressure LRV/URV Configuration	6-10
6.6.8	Damping Time Constant Configuration	6-10
6.6.9	Output Mode Configuration	6-10
6.6.10	Display Out 1 Configuration.....	6-10
6.6.11	Re-range by applying actual pressure (LRV/URV).....	6-11
6.6.12	Device Information Display	6-11
6.6.13	Save or Cancel.....	6-11

6.6.14	Abort Configuration	6-12
6.6.14.1	Abort Configuration (Menu)	6-12
6.6.14.2	Abort Configuration (Parameter)	6-12
6.6.15	Local Parameter Setting Lock.....	6-12
6.6.16	Others	6-12
7.	Maintenance.....	7-1
7.1	Overview	7-1
7.2	Calibration Instruments Selection	7-1
7.3	Calibration	7-1
7.4	Disassembly and Reassembly	7-3
7.4.1	Replacing the Integral Indicator	7-3
7.4.2	Replacing the CPU Board Assembly	7-4
7.5	Troubleshooting.....	7-4
7.5.1	Basic Troubleshooting	7-5
7.5.2	Troubleshooting Flowcharts.....	7-5
7.5.3	Alarms and Countermeasures.....	7-7
8.	General Specifications	8-1
Revision Information		

When using the transmitters in a Safety Instrumented System application, refer to the Functional Safety Manual (Document No.: TI 01C25A05-01EN or TI 01C25A05-21EN for option code SLT) and follow the instructions and procedures described there. The document can be downloaded from the website of Yokogawa. (Website address: <https://www.yokogawa.com/solutions/products-platforms/field-instruments/>)

In order to satisfy the requirement of Safety Instrumented System, executing parameters setting is required. Please refer to the clause of “Setting Parameters” for setting range in the following manuals for the actual operation.

BRAIN: IM 01C25T03-01E
HART: IM 01C25T01-06EN

Please also refer to the contact output setting in the same clause. After installing the transmitter, confirm that the range and unit is set correctly. Calibration of the transmitters shall be done after completing the range setting.

1. Introduction

Thank you for purchasing the DPharp Differential Pressure and pressure transmitter.

Your Pressure Transmitter was precisely calibrated at the factory before shipment. To ensure both safety and efficiency, please read this manual carefully before you operate the instrument.



NOTE

This manual describes the hardware configurations of the transmitters listed in below. For information on the software configuration and operation, please refer to either IM 01C25T03-01E for the BRAIN communication type, or IM 01C25T01-06EN for the HART communication type.

For FOUNDATION Fieldbus protocol type, please refer to IM 01C25T02-01E.

For PROFIBUS PA protocol type, please refer to IM 01C25T04-01EN.

For the specifications, external dimensions, and model, suffix and option codes of each product, please refer to the General Specifications sheet as listed in the Chapter 8.

Model	Style code
EJX118A	S2
EJX438A	S2
EJA118E	S1, S2
EJA438E	S1, S2

To ensure correct use of this instrument, read both the hardware and software manuals thoroughly before use.



WARNING

When using the transmitters in a Safety Instrumented System application, refer to the Functional Safety Manual (Document No.: TI 01C25A05-01EN or TI 01C25A05-21EN for option code SLT) and follow the instructions and procedures described there. The document can be downloaded from the website of Yokogawa. (Website address:

<https://www.yokogawa.com/solutions/products-platforms/field-instruments/>)

In order to satisfy the requirement of Safety Instrumented System, executing parameters setting is required. Please refer to the clause of "Setting Parameters" for setting range in the following manuals for the actual operation.

BRAIN: IM 01C25T03-01E

HART: IM 01C25T01-06EN

Please also refer to the contact output setting in the same clause. After installing the transmitter, confirm that the range and unit is set correctly. Calibration of the transmitters shall be done after completing the range setting.



NOTE

When describing the model name like EJ□118□ or EJ□438□, it shows the applicability for both EJX118A and EJA118E or EJX438A and EJA438E.



NOTE

Unless otherwise stated, the illustrations in this manual are of the EJ□118□ diaphragm sealed differential pressure transmitter.

Users of the EJ□438□ should bear in mind that certain features of their instrument will differ from those shown in the illustrations of the EJ□118□.

■ Regarding This Manual

- This manual and the identification tag attached on the packing box are essential parts of the product. Please keep them in a safe place for future reference.
- This manual should be provided to the end user.
- The contents of this manual are subject to change without prior notice.
- All rights reserved. No part of this manual may be reproduced in any form without Yokogawa’s written permission.
- Yokogawa makes no warranty of any kind with regard to this manual, including, but not limited to, implied warranty of merchantability and fitness for a particular purpose.
- If any question arises or errors are found, or if any information is missing from this manual, please inform the nearest Yokogawa sales office.
- The specifications covered by this manual are limited to those for the standard type under the specified model number break-down and do not cover custom-made instruments.
- Please note that changes in the specifications, construction, or component parts of the instrument may not immediately be reflected in this manual at the time of change, provided that postponement of revisions will not cause difficulty to the user from a functional or performance standpoint.
- Yokogawa assumes no responsibilities for this product except as stated in the warranty.
- If the customer or any third party is harmed by the use of this product, Yokogawa assumes no responsibility for any such harm owing to any defects in the product which were not predictable, or for any indirect damages.
- The following safety symbols are used in this manual:



WARNING

Indicates a potentially hazardous situation which, if not avoided, could result in death or serious injury.



CAUTION

Indicates a potentially hazardous situation which, if not avoided, may result in minor or moderate injury. It may also be used to alert against unsafe practices.



IMPORTANT

Indicates that operating the hardware or software in this manner may damage it or lead to system failure.



NOTE

Draws attention to information essential for understanding the operation and features.

⎓ Direct current

⏏ Functional grounding terminal



Caution

This symbol indicates that the operator must refer to an explanation in the user’s manual in order to avoid the risk of injury or death of personnel or damage to the instrument.

■ Trademarks

- ‘DPharp’, ‘EJX’, ‘EJA’, ‘FieldMate’ and ‘BRAIN TERMINAL’ are registered trademarks of Yokogawa Electric Corporation. Company names and product names used in this material are registered trademarks or trademarks of their respective owners.
- In this manual, trademarks or registered trademarks are not marked with TM or ®.

1.1 Safe Use of This Product

For the safety of the operator and to protect the instrument and the system, please be sure to follow this manual's safety instructions when handling this instrument. If these instructions are not heeded, the protection provided by this instrument may be impaired. In this case, Yokogawa cannot guarantee that the instrument can be safely operated. Please pay special attention to the following points:

(a) Installation



WARNING

- This instrument may only be installed by an engineer or technician who has an expert knowledge of this device. Operators are not allowed to carry out installation unless they meet this condition.
- With high process temperatures, care must be taken not to burn yourself by touching the instrument or its casing.
- Never loosen the process connector nuts when the instrument is installed in a process. This can lead to a sudden, explosive release of process fluids.
- When draining condensate from the pressure detector section, take appropriate precautions to prevent the inhalation of harmful vapors and the contact of toxic process fluids with the skin or eyes.
- When removing the instrument from a hazardous process, avoid contact with the fluid and the interior of the meter.
- All installation shall comply with local installation requirements and the local electrical code.

(b) Wiring



WARNING

- The instrument must be installed by an engineer or technician who has an expert knowledge of this instrument. Operators are not permitted to carry out wiring unless they meet this condition.
- Before connecting the power cables, please confirm that there is no current flowing through the cables and that the power supply to the instrument is switched off.

(c) Operation



WARNING

- Wait 5 min. after power is turned off, before opening the covers.
- Do not open the cover in wet weather or humid environment. If the cover is opened, stated enclosure protection is not applicable.

(d) Maintenance



WARNING

- Please carry out only the maintenance procedures described in this manual. If you require further assistance, please contact the nearest Yokogawa office.
- Care should be taken to prevent the build up of dust or other materials on the display glass and the name plate. To clean these surfaces, use a soft, dry cloth.

(e) Explosion Protected Type Instrument



WARNING

- Users of explosion proof instruments should refer first to section 2.9 (Installation of an Explosion Protected Instrument) of this manual.
- The use of this instrument is restricted to those who have received appropriate training in the device.
- Take care not to create sparks when accessing the instrument or peripheral devices in a hazardous location.

(f) Modification



WARNING

- Yokogawa will not be liable for malfunctions or damage resulting from any modification made to this instrument by the customer.

(g) Product Disposal

- The instrument should be disposed of in accordance with local and national legislation/regulations.

(h) Authorized Representative in EEA

- In relation to the CE Marking, The authorised representative for this product in the EEA (European Economic Area) is: Yokogawa Europe B.V. Euroweg 2, 3825 HD Amersfoort, The Netherlands

(i) Control of Pollution Caused by the Product

This is an explanation for the product based on “Control of Pollution caused by Electronic Information Products” in the People’s Republic of China. The information is valid only in China.

产品中有害物质或元素的名称及含量

型号	部件名称	有害物质					
		铅 (Pb)	汞 (Hg)	镉 (Cd)	六价铬 (Cr(VI))	多溴联苯 (PBB)	多溴二苯醚 (PBDE)
EJX/EJA-E Series 差压/压力变送器	壳体	×	○	○	○	○	○
	膜盒组件	×	○	○	○	○	○
	基板组件	×	○	○	○	○	○
	电源连接线	×	○	○	○	○	○
○：表示该部件的所有均质材料中的有害物质的含量均在 GB/T26572 标准中所规定的限量以下。							
×：表示至少该部件的某些均质材料中的有害物质的含量均在 GB/T26572 标准中所规定的限量以上。							

环保使用期限：



该标识适用于 SJ /T11364 中所述，在中华人民共和国销售的电子电气产品的环保使用期限。

注) 该年数为“环保使用期限”，并非产品的质量保证期。

1.2 Warranty

- The warranty shall cover the period noted on the quotation presented to the purchaser at the time of purchase. Problems occurring during the warranty period shall basically be repaired free of charge.
- If any problems are experienced with this instrument, the customer should contact the Yokogawa representative from which this instrument was purchased or the nearest Yokogawa office.
- If a problem arises with this instrument, please inform us of the nature of the problem and the circumstances under which it developed, including the model specification and serial number. Any diagrams, data and other information you can include in your communication will also be helpful.
- The party responsible for the cost of fixing the problem shall be determined by Yokogawa following an investigation conducted by Yokogawa.
- The purchaser shall bear the responsibility for repair costs, even during the warranty period, if the malfunction is due to:
 - Improper and/or inadequate maintenance by the purchaser.
 - Malfunction or damage due to a failure to handle, use, or store the instrument in accordance with the design specifications.
 - Use of the product in question in a location not conforming to the standards specified by Yokogawa, or due to improper maintenance of the installation location.
 - Failure or damage due to modification or repair by any party except Yokogawa or an approved representative of Yokogawa.
 - Malfunction or damage from improper relocation of the product in question after delivery.
 - Reason of force majeure such as fires, earthquakes, storms/floods, thunder/lightening, or other natural disasters, or disturbances, riots, warfare, or radioactive contamination.

2. Handling Cautions

This chapter provides important information on how to handle the transmitter. Read this carefully before using the transmitter.

The transmitters are thoroughly tested at the factory before shipment. When taking delivery of an instrument, visually check them to make sure that no damage occurred during shipment.

Also check that all transmitter mounting hardware shown in figure 2.1 is included. If the transmitter is ordered without the mounting bracket, the transmitter mounting hardware will not be included. After checking the transmitter, carefully repack it in its box and keep it there until you are ready to install it.

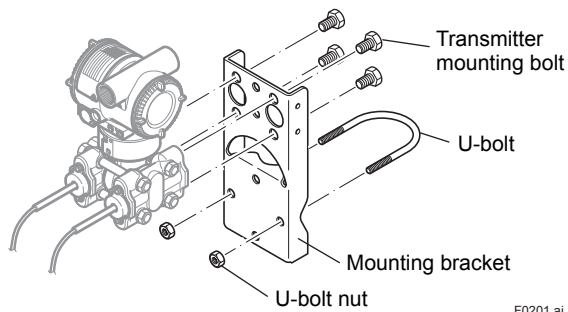

Figure 2.1 Transmitter Mounting Hardware

2.1 Model and Specifications Check

The model name and specifications are written on the name plate attached to the case.

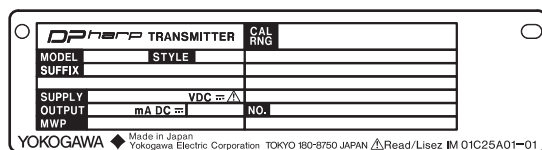

Figure 2.2 Name Plate

2.2 Unpacking

Keep the transmitter in its original packaging to prevent it from being damaged during shipment. Do not unpack the transmitter until it reaches the installation site.

2.3 Storage

The following precautions must be observed when storing the instrument, especially for a long period.

- (a) Select a storage area which meets the following conditions:
 - It is not exposed to rain or subject to water seepage/leaks.
 - Vibration and shock are kept to a minimum.
 - It has an ambient temperature and relative humidity within the following ranges.

Ambient temperature:

–40* to 85°C without integral indicator

–30* to 80°C with integral indicator

* –15°C when /HE is specified.

Relative humidity:

0% to 100% R.H. (at 40°C)

Preferred temperature and humidity:

approx. 25°C and 65% R.H.

- (b) When storing the transmitter, repack it carefully in the packaging that it was originally shipped with.
- (c) If the transmitter has been used, thoroughly clean the diaphragm surface of the diaphragm seal (pressure-detector section), so that there is no process fluid remaining on them. Before placing it in storage, also make sure that the pressure-detector is securely connected to the transmitter section.

2.4 Selecting the Installation Location

The transmitter is designed to withstand severe environmental conditions. However, to ensure that it will provide years of stable and accurate performance, take the following precautions when selecting the installation location.

- (a) Ambient Temperature
Avoid locations subject to wide temperature variations or a significant temperature gradient. If the location is exposed to direct sunlight or radiant heat from plant equipment, provide adequate shade, thermal insulation and/or ventilation.
- (b) Ambient Atmosphere
Do not install the transmitter in a corrosive atmosphere. If this cannot be avoided, there must be adequate ventilation as well as measures to prevent the leaking of rain water and the presence of standing water in the conduits.
- (c) Shock and Vibration
Although the transmitter is designed to be relatively resistant to shock and vibration, an installation site should be selected where this is kept to a minimum.
- (d) Installation of Explosion-protected Transmitters
An explosion-protected transmitter is certified for installation in a hazardous area containing specific gas types. See subsection 2.9 "Installation of an Explosion-Protected Transmitters."

2.5 Pressure Connection



CAUTION

- Never loosen the process flange bolts when an instrument is installed in a process. The device is under pressure, and a loss of seal can result in a sudden and uncontrolled release of process fluid.
- Since the accumulated process fluid may be toxic or otherwise harmful, take appropriate steps to prevent the contact of such fluids with the skin or eyes and the inhalation of vapors from these fluids even after dismantling the instrument from process line for maintenance.

The following precautions must be observed in order to safely operate the transmitter under pressure.

- (a) Make sure that there are no leaks in the impulse piping.
- (b) Never apply a pressure higher than the specified maximum working pressure.

2.6 Waterproofing of Cable Conduit Connections

Apply a non-hardening sealant to the threads to waterproof the transmitter cable conduit connections. (See figure 5.8, 5.9 and 5.10.)

2.7 Restrictions on Use of Radio Transceivers



IMPORTANT

Although the transmitter has been designed to resist high frequency electrical noise, if a radio transceiver is used near the transmitter or its external wiring, the transmitter may be affected by high frequency noise pickup. To test this, start out from a distance of several meters and slowly approach the transmitter with the transceiver while observing the measurement loop for noise effects. Thereafter use the transceiver outside the range where the noise effects were first observed.

2.8 Insulation Resistance and Dielectric Strength Test

Since the transmitter has undergone insulation resistance and dielectric strength tests at the factory before shipment, normally these tests are not required. If the need arises to conduct these tests, heed the following:

- (a) Do not perform such tests more frequently than is absolutely necessary. Even test voltages that do not cause visible damage to the insulation may degrade the insulation and reduce safety margins.
- (b) Never apply a voltage exceeding 500 V DC (100 V DC with an internal lightning protector) for the insulation resistance test, nor a voltage exceeding 500 V AC (100 V AC with an internal lightning protector) for the dielectric strength test.
- (c) Before conducting these tests, disconnect all signal lines from the transmitter terminals. The procedure for conducting these tests is as follows:

• Insulation Resistance Test

- 1) Short-circuit the + and – SUPPLY terminals in the terminal box. In case of 1 to 5 V output, short-circuit the SUPPLY+, SUPPLY – and A (VOUT +) terminals.
- 2) Turn OFF the insulation tester. Then connect the insulation tester plus (+) lead wire to the shorted SUPPLY terminals and the minus (–) leadwire to the grounding terminal.
- 3) Turn ON the insulation tester power and measure the insulation resistance. The voltage should be applied as briefly as possible to verify that the insulation resistance is at least 20 MΩ.
- 4) After completing the test and being very careful not to touch exposed conductors disconnect the insulation tester and connect a 100 kΩ resistor between the grounding terminal and the short-circuiting SUPPLY terminals. Leave this resistor connected at least one second to discharge any static potential. Do not touch the terminals while it is discharging.

• Dielectric Strength Test

- 1) Short-circuit the + and – SUPPLY terminals in the terminal box. In case of 1 to 5 V output, short-circuit the SUPPLY+, SUPPLY – and A (VOUT +) terminals.
- 2) Turn OFF the dielectric strength tester. Then connect the tester between the shorted SUPPLY terminals and the grounding terminal. Be sure to connect the grounding lead of the dielectric strength tester to the ground terminal.
- 3) Set the current limit on the dielectric strength tester to 25 mA, then turn ON the power and gradually increase the test voltage from '0' to the specified voltage.
- 4) When the specified voltage is reached, hold it for one minute.
- 5) After completing this test, slowly decrease the voltage to avoid any voltage surges.

2.9 Installation of an Explosion-Protected Instrument



NOTE

For FOUNDATION Fieldbus explosion protected type, please refer to IM 01C25T02-01E.

For PROFIBUS PA explosion protected type, please refer to IM 01C25T04-01EN.

If a customer makes a repair or modification to an intrinsically safe or explosionproof instrument and the instrument is not restored to its original condition, its intrinsically safe or explosionproof construction may be compromised and the instrument may be hazardous to operate. Please contact Yokogawa before making any repair or modification to an instrument.



CAUTION

This instrument has been tested and certified as being intrinsically safe or explosionproof. Please note that severe restrictions apply to this instrument's construction, installation, external wiring, maintenance and repair. A failure to abide by these restrictions could make the instrument a hazard to operate.



WARNING

Maintaining the safety of explosionproof equipment requires great care during mounting, wiring, and piping. Safety requirements also place restrictions on maintenance and repair. Please read the following sections very carefully.



WARNING

The range setting switch must not be used in a hazardous area.



IMPORTANT

For combined approval types
Once a device of multiple approval type is installed, it should not be re-installed using any other approval types. Apply a permanent mark in the check box of the selected approval type on the certification label on the transmitter to distinguish it from unused approval types.



IMPORTANT

All the blind plugs which accompany the EJX/EJA-E transmitters upon shipment from the factory are certified by the applicable agency in combination with those transmitters. The plugs which are marked with the symbols "∅ Ex" on their surfaces are certified only in combination with the EJX/EJA-E series transmitters.

2.9.1 FM Approval

a. FM Intrinsically Safe/Nonincendive for HART/BRAIN Protocol Type

Note 1. EJX/EJA-E Series pressure transmitters with optional code /FS1 are applicable for use in hazardous locations.

- Applicable Standard:
 - FM 3600:2011
 - FM 3610:2010
 - FM 3611:2004
 - FM 3810:2005
 - ANSI/ISA-60079-0-2009
 - ANSI/ISA-60079-11-2009
 - ANSI/ISA-61010-1-2004
 - NEMA 250:1991
- Rating
 - Intrinsically Safe for Class I, II, III Division 1, Groups A, B, C, D, E, F, G T4
 - Class I Zone 0 AEx ia IIC T4
 - Nonincendive for Class I, II, III Division 2 Groups A, B, C, D, F, G T4
 - Class I, Zone 2 Group IIC T4
- Ambient temperature: -60 to 60°C
- Enclosure: Type 4X

Note 2. Installation

Installation should be in accordance with Control Drawing IFM022-A12.

Note 3. Specific conditions of use

Precautions shall be taken to minimize the risk from electrostatic discharge of painted parts. When the enclosure of the Pressure Transmitters is made of aluminum alloy, if it is mounted in Zone 0, it shall be installed such that, even in the event of rare incidents, an ignition source due to impact and/or friction sparks is excluded.

Note 4. Maintenance and Repair

Only personnel authorized by Yokogawa Electric Corporation can repair the equipment.

Model: EJX Series Date: October 22, 2003
Control Drawing

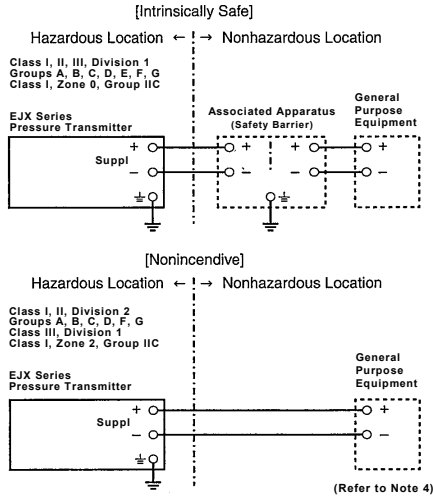

Rev.2: July 16, 2019 Doc. No.: IFM022-A12 P.1
Yokogawa Electric Corporation

Model: EJX Series Date: October 22, 2003

Specific conditions of use:
- Precautions shall be taken to minimize the risk from electrostatic discharge of painted parts.
- When the enclosure of the Pressure Transmitters is made of aluminum alloy, if it is mounted in Zone 0, it must be installed such that, even in the event of rare incidents, an ignition source due to impact and/or friction sparks is excluded.

Entity Parameters [Groups: A, B, C, D, E, F and G]
Vmax: 30 V
Imax: 200 mA
Pmax: 1 W
Ci: 6 nF
Li: 0 μH
Entity Parameters [Groups: C, D, E, F and G]
Vmax: 30 V
Imax: 225 mA
Pmax: 1 W
Ci: 6 nF
Li: 0 μH

- Notes:
- Installation must be in accordance with the National Electric Code (NFPA70), ANSI/ISA-RP12.06.01, and relevant local codes.
 - The Associated Apparatus must be FM-approved.
 - The following conditions must be satisfied.
 $V_{oc} \text{ (or } U_o) \leq V_{max}$
 $I_{sc} \text{ (or } I_o) \leq I_{max}$
 $P_o \leq P_{max}$
 $C_a \text{ (or } C_o) \geq C_i + C_{cable}$
 $L_a \text{ (or } L_o) \geq L_i + L_{cable}$
 - In case Nonincendive Field Wiring Concept is used for the interconnection, FM-approved Associated Nonincendive Field Wiring Apparatus, which meets the above conditions, must be used as the General Purpose Equipment.
 - The General Purpose Equipment connected to the Associated Apparatus must not use or generate a voltage more than U_m of the Associated Apparatus.
 - The control drawing of the Associated Apparatus must be followed when installing the equipment.
 - Dust-tight conduit seals must be used when installed in Class II or Class III environments.
 - WARNING –ELECTROSTATIC CHARGE MAY CAUSE AN EXPLOSION HAZARD. AVOID ANY ACTIONS THAT CAUSE THE GENERATION OF ELECTROSTATIC CHARGE, SUCH AS RUBBING WITH A DRY CLOTH ON COATING FACE OF THE PRODUCT.
 - WARNING – SUBSTITUTION OF COMPONENTS MAY IMPAIR INTRINSIC SAFETY AND SUITABILITY FOR HAZARDOUS LOCATION

Rev.3: July 16, 2019 Doc. No.: IFM022-A12 P.2
Yokogawa Electric Corporation

b. FM Explosionproof Type

Caution for FM explosionproof type.

Note 1. EJX/EJA-E Series pressure transmitters with optional code /FF1 are applicable for use in hazardous locations.

- Applicable Standard: FM3600:2018, FM3615:2018, FM3810:2018, NEMA 250:2003, ANSI/UL 61010-1:2012, ANSI/UL 61010-2-30:2012
- Explosionproof for Class I, Division 1, Groups B, C and D.
- Dust-ignitionproof for Class II/III, Division 1, Groups E, F and G.
- Enclosure: Type 4X
- Temperature Class: T6
- Ambient Temperature: -40 to 60°C
- Supply Voltage: 42 V dc max. 32 V dc max. (FOUNDATION Fieldbus and PROFIBUS PA type) 9 to 28 V dc, 27 mW (Low Power type)
- Output signal: 4 to 20 mA 15 mA (FOUNDATION Fieldbus and PROFIBUS PA type) 1 to 5 V (Low Power type)

Note 2. Wiring

- All wiring shall comply with National Electrical Code ANSI/NFPA70 and Local Electrical Codes.
- When installed in Division 1, "FACTORY SEALED, CONDUIT SEAL NOT REQUIRED."
- Wiring connection for output signal code Q (Low Power type) shall follow the diagram below.

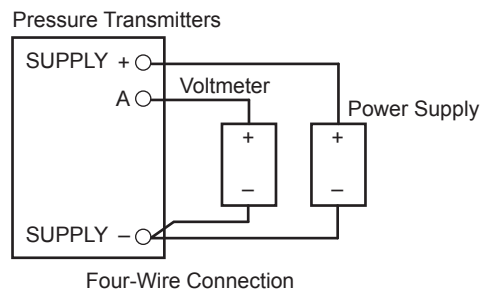
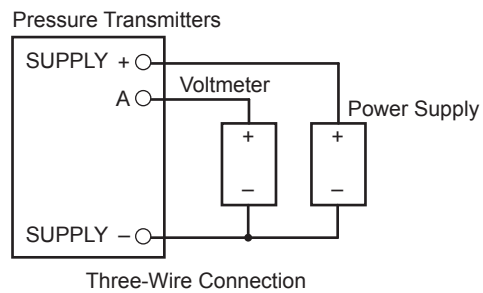

F0211.ai

Note 3. Operation

- Keep the “WARNING” nameplate attached to the transmitter.
WARNING: OPEN CIRCUIT BEFORE REMOVING COVER. FACTORY SEALED, CONDUIT SEAL NOT REQUIRED. INSTALL IN ACCORDANCE WITH THE USERS MANUAL IM 01C25.
- Take care not to generate mechanical sparking when accessing to the instrument and peripheral devices in a hazardous location.

Note 4. Maintenance and Repair

- The instrument modification or parts replacement by other than authorized representative of Yokogawa Electric Corporation is prohibited and will void Factory Mutual Explosionproof Approval.

c. FM Intrinsically Safe Type/FM Explosionproof Type

EJX/EJA-E Series pressure transmitters with optional code /FU1 or /V1U1 can be selected the type of protection (FM Intrinsically Safe or FM Explosionproof) for use in hazardous locations.

Note 1. For the installation of this transmitter, once a particular type of protection is selected, any other type of protection cannot be used. The installation must be in accordance with the description about the type of protection in this instruction manual.

Note 2. In order to avoid confusion, cross out unnecessary markings on the label other than the selected type of protection when the transmitter is installed.

2.9.2 CSA Certification

a. CSA Intrinsically Safe Type

Caution for CSA Intrinsically safe and nonincendive type. (Following contents refer to “DOC No. ICS013-A13”)

Note 1. EJX/EJA-E Series differential, gauge, and absolute pressure transmitters with optional code /CS1 are applicable for use in hazardous locations

Certificate: 1606623

Applicable Standard:

- C22.2 No.0
- C22.2 No.94
- C22.2 No.157
- C22.2 No.213
- C22.2 No.61010-1
- C22.2 No.61010-2-030
- CAN/CSA-C22.2 60079-0:07
- CAN/CSA-E60079-11:02
- CAN/CSA-E60079-15:02
- CAN/CSA-C22.2 No.60529
- ANSI/ISA-12.27.01

[For Devision system]

- Intrinsically Safe for Class I, Division 1, Groups A, B, C & D, Class II, Division 1, Groups E, F & G, Class III, Division 1
- Nonincendive for Class I, Division 2, Groups A, B, C & D, Class II, Division 2, Groups F & G, Class III, Division 1
- Enclosure: Type 4X
- Temp. Code: T4
- Amb. Temp.: -50* to 60°C
* -15°C when /HE is specified.
- Process Temperature: 120°C max.

[For Zone system]

- Ex ia IIC T4, Ex nL IIC T4
- Ambient Temperature: -50* to 60°C
* -15°C when /HE is specified.
- Max. Process Temp.: 120°C
- Enclosure: IP66/IP67

Note 2. Entity Parameters

- Intrinsically safe ratings are as follows:
Maximum Input Voltage (Vmax/Ui) = 30 V
Maximum Input Current (Imax/Ii) = 200 mA
Maximum Input Power (Pmax/Pi) = 0.9 W
Maximum Internal Capacitance (Ci) = 10 nF
Maximum Internal Inductance (Li) = 0 μH
- Type “n” or Nonincendive ratings are as follows:
Maximum Input Voltage (Vmax/Ui) = 30 V
Maximum Internal Capacitance (Ci) = 10 nF
Maximum Internal Inductance (Li) = 0 μH
- Installation Requirements
Uo ≤ Ui, Io ≤ Ii, Po ≤ Pi,
Co ≥ Ci + Ccable, Lo ≥ Li + Lcable
Voc ≤ Vmax, Isc ≤ Imax,
Ca ≥ Ci + Ccable, La ≥ Li + Lcable
Uo, Io, Po, Co, Lo, Voc, Isc, Ca and La are parameters of barrier.

Note 3. Installation

- In any safety barrier used output current must be limited by a resistor 'R' such that $I_o=U_o/R$ or $I_{sc}=V_{oc}/R$.
- The safety barrier must be CSA certified.
- Input voltage of the safety barrier must be less than 250 Vrms/Vdc.
- Installation should be in accordance with Canadian Electrical Code Part I and Local Electrical Code.
- Dust-tight conduit seal must be used when installed in Class II and III environments.
- The instrument modification or parts replacement by other than authorized representative of Yokogawa Electric Corporation and Yokogawa Corporation of America is prohibited and will void Canadian Standards Intrinsically safe and nonincendive Certification.

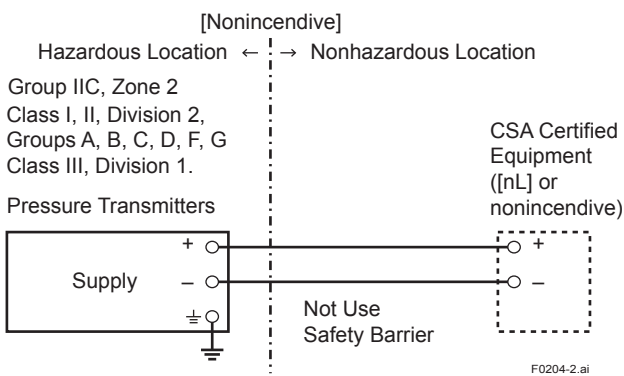
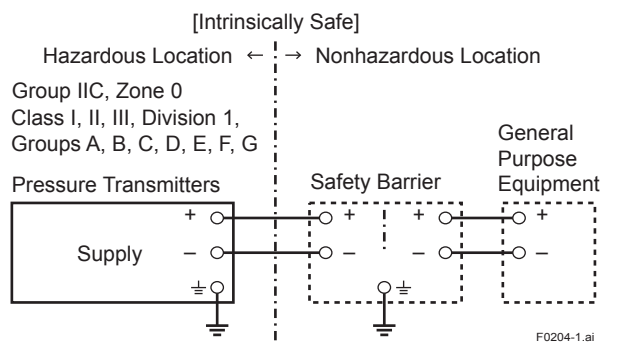

b. CSA Explosionproof Type

Caution for CSA explosionproof type.

Note 1. EJX/EJA-E Series pressure transmitters with optional code /CF1 are applicable for use in hazardous locations:

- Certificate: 2014354
- Applicable Standard:
C22.2 No. 25
C22.2 No. 30
CAN/CSA-C22.2 No. 94
CAN/CSA-C22.2 No. 61010-1-12
CAN/CSA-C22.2 No. 61010-2-030-12
CAN/CSA-C22.2 No. 60079-0:07
CAN/CSA-C22.2 No. 60079-1:07
CAN/CSA-C22.2 No. 60529
ANSI/ISA-12.27.01
- Explosion-proof for Class I, Groups B, C and D.
- Dustignition-proof for Class II/III, Groups E, F and G.
- Enclosure: Type 4X
- Temperature Code: T6...T4
- Ex d IIC T6...T4
- Enclosure: IP66/IP67
- Maximum Process Temperature: 120°C (T4), 100°C (T5), 85°C (T6)
- Ambient Temperature: -50* to 75°C (T4), -50* to 80°C (T5), -50* to 75°C (T6)
* -15°C when /HE is specified.
- Supply Voltage: 42 V dc max.
32 V dc max. (FOUNDATION Fieldbus and PROFIBUS PA type)
9 to 28 V dc, 27 mW (Low Power type)
- Output Signal: 4 to 20 mA dc
15 mA (FOUNDATION Fieldbus and PROFIBUS PA type)
1 to 5 V (Low Power type)

Note 2. Wiring

- All wiring shall comply with Canadian Electrical Code Part I and Local Electrical Codes.
- In hazardous location, wiring shall be in conduit as shown in the figure.
- **WARNING:**
A SEAL SHALL BE INSTALLED WITHIN 45cm OF THE ENCLOSURE.
UN SCÉLLEMENT DOIT ÊTRE INSTALLÉ À MOINS DE 45cm DU BOÎTIER.
- **WARNING:**
WHEN INSTALLED IN CL.I, DIV 2, SEAL NOT REQUIRED.
UNE FOIS INSTALLÉ DANS CL I, DIV 2, AUCUN JOINT N'EST REQUIS.

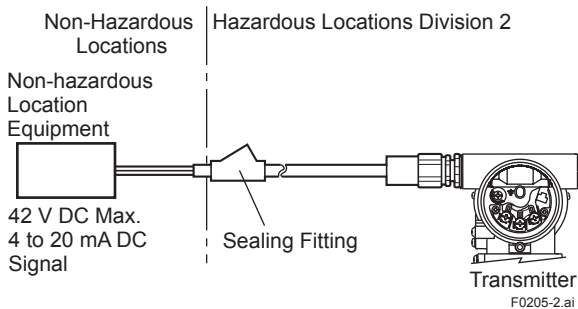
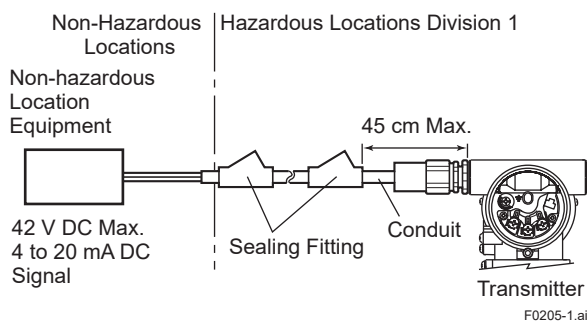

- All wiring shall comply with local installation requirements and local electrical code.
- In hazardous locations, the cable entry devices shall be of a certified flameproof type, suitable for the conditions of use and correctly installed.
- Unused apertures shall be closed with suitable flameproof certified blanking elements. (The plug attached is flameproof certified.)

- Wiring connection for output signal code Q (Low Power type) shall follow the diagram below.

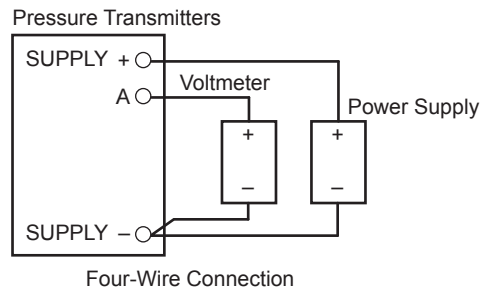
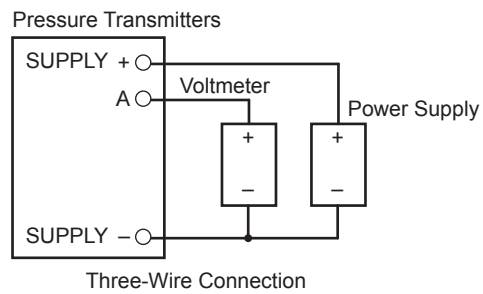

F0212.ai

Note 3. Operation

- **WARNING:**
AFTER DE-ENERGIZING, DELAY 5 MINUTES BEFORE OPENING.
APRÈS POWER-OFF, ATTENDRE 5 MINUTES AVANT D'OUVRIR.
- **WARNING:**
WHEN AMBIENT TEMPERATURE $\geq 65^{\circ}\text{C}$, USE THE HEAT-RESISTING CABLES $\geq 90^{\circ}\text{C}$.
QUAND LA TEMPÉRATURE AMBIANTE $\geq 65^{\circ}\text{C}$, UTILISEZ DES CÂBLES RÉSISTANTES À LA CHALEUR $\geq 90^{\circ}\text{C}$.
- Take care not to generate mechanical sparking when accessing to the instrument and peripheral devices in a hazardous location.

Note 4. Maintenance and Repair

- The instrument modification or parts replacement by other than authorized representative of Yokogawa Electric Corporation and Yokogawa Corporation of America is prohibited and will void Canadian Standards Explosionproof Certification.

c CSA Intrinsically Safe Type/CSA Explosionproof Type

EJX/EJA-E Series pressure transmitters with optional code /CU1 or /V1U1 can be selected the type of protection (CSA Intrinsically Safe or CSA Explosionproof) for use in hazardous locations.

Note 1. For the installation of this transmitter, once a particular type of protection is selected, any other type of protection cannot be used. The installation must be in accordance with the description about the type of protection in this instruction manual.

Note 2. For combined approval types, once a device of multiple approval type is installed, it should not be re-installed using any other approval types. Apply a permanent mark in the check box of the selected approval type on the certification label on the transmitter to distinguish it from unused approval types.

2.9.3 ATEX Certification

(1) Technical Data

a. ATEX Intrinsically Safe Ex ia

Caution for ATEX Intrinsically safe type.

Note 1. EJX/EJA-E Series pressure transmitters with optional code /KS21 for use in hazardous locations

- Applicable standards: EN IEC 60079-0, EN 60079-11
- Certificate number: DEKRA 11ATEX0228 X
- Specific Ex marking:

II 1 G Ex ia IIC T4 Ga
 II 2 D Ex ia IIIC T85°C T100°C T120°C Db

- Ambient temperature:
 EPL Ga $-50^{\circ}\text{C} \leq \text{Ta} \leq +60^{\circ}\text{C}$
 EPL Db $-30^{\circ}\text{C} \leq \text{Ta} \leq +60^{\circ}\text{C}$
 EPL Db * $-15^{\circ}\text{C} \leq \text{Ta} \leq +60^{\circ}\text{C}$

- Process temperature:
 EPL Ga $-50^{\circ}\text{C} \leq \text{Tp} \leq +120^{\circ}\text{C}$
 EPL Db T120°C $-30^{\circ}\text{C} \leq \text{Tp} \leq +120^{\circ}\text{C}$
 T100°C $-30^{\circ}\text{C} \leq \text{Tp} \leq +100^{\circ}\text{C}$
 T85°C $-30^{\circ}\text{C} \leq \text{Tp} \leq +80^{\circ}\text{C}$
 EPL Db * T120°C $-15^{\circ}\text{C} \leq \text{Tp} \leq +120^{\circ}\text{C}$
 T100°C $-15^{\circ}\text{C} \leq \text{Tp} \leq +100^{\circ}\text{C}$
 T85°C $-15^{\circ}\text{C} \leq \text{Tp} \leq +80^{\circ}\text{C}$

* When FKM O-rings are used. (/HE is specified.)

- Enclosure: IP66/IP67 in accordance with EN IEC 60079-0
- Power supply: $\leq 30\text{ V}$, $\leq 21.6\text{ mA}$
- Dielectric strength:
 500 V AC, r.m.s., Terminals: to Enclosure
 1 min Supply +
 Supply -

Note 2. Specific condition of use

When the equipment is mounted in an area where the use of Category 1 G equipment is required, it shall be installed in such a way that, even in the event of rare incidents, an ignition source due to impact and/or friction sparks is excluded.

Precaution shall be taken to minimize the risk from electrostatic discharges or propagating brush discharges on the non-metallic parts (excluding glass parts) or coated parts of the equipment.

The dielectric strength of at least 500 V of the intrinsically safe circuits of the equipment is limited only by the overvoltage protection. From the safety point of view, the intrinsically safe circuit of the equipment shall be assumed to be connected to earth.

Note 3. Installation and erection

Cable entry devices suitable for the thread form and the size of the cable entries must be used, according to the following marking on the equipment.

Screw Size	Marking
ISO M20 × 1.5 female	$\triangle M$
ANSI 1/2 NPT female	$\triangle A$ or $\triangle N$ or $\triangle W$

F0218.ai

When installing the equipment, the selected Type of Protection should be ticked as follows.

- Ex ia IIC T4 Ga
- Ex ia IIIC T85°C T100°C T120°C Db

See the control drawing.

Note 4. Use and setting-up (operation)

If the equipment is mounted in an area where explosive atmospheres may be present, it must be installed in such a way that the risk from electrostatic discharges and propagating brush discharges caused by rapid flow of dust are avoided.

Note 5. Maintenance and repair



WARNING

A modification of the equipment would no longer comply with the construction described in the certificate documentation.

Only personnel authorized by Yokogawa Electric Corporation can repair the equipment.

Yokogawa Electric Corporation		Model		EJX Series	
Title	Control drawing (General)				
No.	IKE045-A9f	Page	1	Revision	0
Date	2020-08-07				

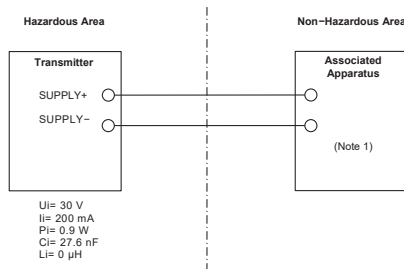

Notes:
1. Associated Apparatus must be a linear power source whose output current is resistively limited.

- Enclosure: IP66 / IP67
- Temperature Class for gas-proof: T6, T5, and T4
- Ambient Temperature for gas-proof: -50 to 75°C (T6), -50 to 80°C (T5), and -50 to 75°C (T4)
- Process Temperature (Tp.) for gas-proof: -50 to 85°C (T6), -50 to 100°C (T5), and -50 to 120°C (T4)
- Maximum Surface Temperature for dust-proof: T85°C (Tamb.: -30* to 75°C, Tp.: -30* to 85°C)
* -15°C when /HE is specified.

Note 2. Electrical Data

- Supply voltage: 42 V dc max. 32 V dc max. (FOUNDATION Fieldbus and PROFIBUS PA type)
9 to 28 V dc, 27 mW (Low Power type)
9 to 30 V dc, 250 mW (RS485 Modbus Communication Type)
- Output signal: 4 to 20 mA
15 mA (FOUNDATION Fieldbus and PROFIBUS PA type)
1 to 5 V (Low Power type)
RS485 Modbus (RS485 Modbus Communication Type)

Note3. For combined approval types Once a device of multiple approval type is installed, it should not be re-installed using any other approval types. Apply a permanent mark in the check box of the selected approval type on the certification label on the transmitter to distinguish it from unused approval types.

Note 4. Installation

- All wiring shall comply with local installation requirement.
- In order to prevent the earthing conductor from loosening, the conductor must be secured to the terminal, tightening the screw with appropriate torque. Care must be taken not to twist the conductor.
- Cable glands, adapters and/or blanking elements with a suitable IP rating shall be of Ex d IIC/Ex tb IIIC certified by ATEX and shall be installed so as to maintain the specific degree of protection (IP Code) of the equipment.

b. ATEX Flameproof Type

Caution for ATEX flameproof type.

Note 1. EJX/EJA-E Series pressure transmitters with optional code /KF22 are applicable for use in hazardous locations.

- No. KEMA 07ATEX0109 X
- Applicable Standard:
EN IEC 60079-0
EN 60079-1, EN 60079-31
- Type of Protection and Marking Code:

II 2 G Ex db IIC T6...T4 Gb
 II 2 D Ex tb IIIC T85°C Db

- Wiring connection for output signal code Q (Low Power type) shall follow the diagram below.

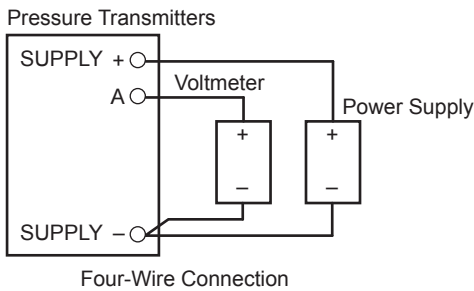
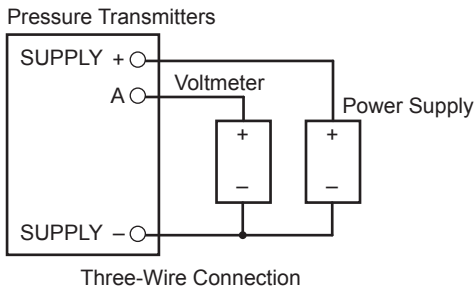

F0213.ai

Note 5. Operation

- Keep the “WARNING” label attached to the transmitter.
WARNING: AFTER DE-ENERGIZING, DELAY 5 MINUTES BEFORE OPENING. WHEN THE AMBIENT TEMP. ≥ 65°C, USE HEAT-RESISTING CABLE AND CABLE GLAND ≥ 90°C.
- Take care not to generate mechanical sparking when accessing to the instrument and peripheral devices in a hazardous location.

Note 6. Maintenance and Repair

- Warning: When maintenance and repair are performed, confirm the following conditions and then perform works.
Confirm the power supply is cut off and the voltage of power supply terminal is not supplied.
- Only personnel authorized by Yokogawa Electric Corporation can repair the equipment in accordance with the relevant standards: IEC / EN 60079-19 (Equipment repair, overhaul and reclamation) and IEC / EN 60079-17 (Electrical installation inspection and maintenance); otherwise the certification will be voided.

Note 7. Specific Conditions of Use



WARNING

- Electrostatic charge may cause an explosion hazard. Avoid any actions that cause the generation of electrostatic charge, such as rubbing with a dry cloth on coating face of the product.
- In the case where the enclosure of the Pressure Transmitter is made of aluminium, if it is mounted in an area where the use of category 2D apparatus is required, it shall be installed in such a way that the risk from electrostatic discharges and propagating brush discharges caused by rapid flow of dust is avoided.
- The flame paths differ from the standard values in EN 60079-1. Repair of the equipment is only allowed when done by the manufacturer or an authorised representative.
- The fasteners used to fasten the transmitter enclosure onto the sensor capsule is special fastener, and the property class of it is A2-50(A4-50) or more.
- For transmitters with a membrane made of titanium, ignition hazard due to impact and friction on the membranes shall be avoided.
- Maximum Surface Temperature for dust-proof: T85°C (Tamb.: -30* to 75°C, Tp.: -30* to 85°C)
* -15°C when /HE is specified.

c. ATEX Intrinsically Safe Type/ATEX Flameproof Type

EJX/EJA-E Series pressure transmitters with optional code /KU22 or /V1U1 can be selected the type of protection ATEX Flameproof, Intrinsically Safe. Ex ia, or Ex ic for use in hazardous area.

Note 1. For the installation of this transmitter, once a particular type of protection is selected, any other type of protection cannot be used. The installation must be in accordance with the description about the type of protection in this user’s manual.

Note 2. For combined approval types Once a device of multiple approval type is installed, it should not be re-installed using any other approval types. Apply a permanent mark in the check box of the selected approval type on the certification label on the transmitter to distinguish it from unused approval types.

• **ATEX Intrinsically Safe Ex ic**

Caution for ATEX intrinsically safe Ex ic

- Applicable standards:
EN IEC 60079-0, EN 60079-11
- Specific Ex Marking:
II 3 G □ Ex ic IIC T4 Gc
- Ambient temperature:
-30°C ≤ Ta ≤ +60°C
-15°C ≤ Ta ≤ +60°C *
- Process temperature:
-30°C ≤ Tp ≤ +120°C
-15°C ≤ Tp ≤ +120°C *
- * When FKM O-rings are used. (/HE is specified.)
- Enclosure: IP66
- Pollution degree: 2
- Overvoltage category: I
- Power supply: ≤ 30 V, ≤ 21.6 mA
- Dielectric strength (Note 3)
500 V AC, r.m.s., Terminals: to Enclosure
1 min Supply +
 Supply -

- Specific condition of use:
Precaution shall be taken to minimize the risk from electrostatic discharges on the non-metallic parts (excluding glass parts) or coated parts of the equipment.
The dielectric strength of at least 500 V of the intrinsically safe circuits of the equipment is limited only by the overvoltage protection. From the safety point of view, the intrinsically safe circuit of the equipment shall be assumed to be connected to earth.
- Installation and erection:
Cable entry devices suitable for the thread form and the size of the cable entries must be used, according to the following marking on the equipment.

Screw Size	Marking
ISO M20 × 1.5 female	△ M
ANSI 1/2 NPT female	△ A or △ N or △ W

F0218.ai

When installing the equipment, the selected Type of Protection should be ticked as follows.

- Ex ic IIC T4 Gc
- Ex ia IIC T4 Ga

- Use and setting-up (operation):
If the pressure transmitter is mounted in an area where explosive atmospheres may be present, it must be installed in such a way that the risk from electrostatic discharges.
- Maintenance and repair:



WARNING

A modification of the equipment would no longer comply with the construction described in the certificate documentation.
Only personnel authorized by Yokogawa Electric Corporation can repair the equipment.

Yokogawa Electric Corporation		Model	EJX Series				
Title	Control drawing		Prepared by	M. Inatomi			
No.	IKE046-A70	Page	1	Approved by	D. Harada		
Revised pages	1-2			Revision	2	Date	2020-09-02

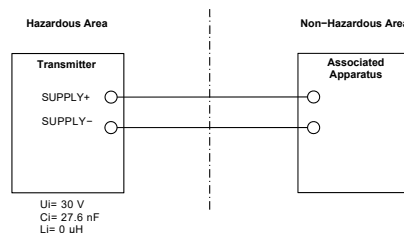

(2) Electrical Connection

A mark indicating the electrical connection type is stamped near the electrical connection port.

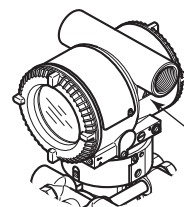

Location of the mark

F0208.ai

(3) Name Plate

• Name plate

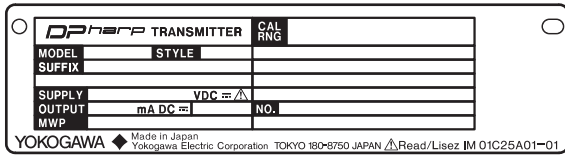

• Tag plate for flameproof type

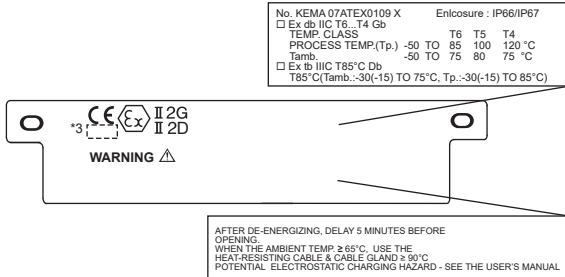

• Tag plate for intrinsically safe type EX ia

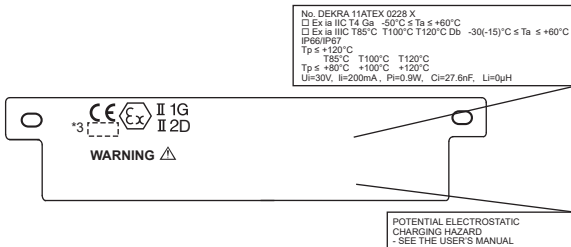

• Tag plate for ATEX intrinsically safe or ATEX flameproof

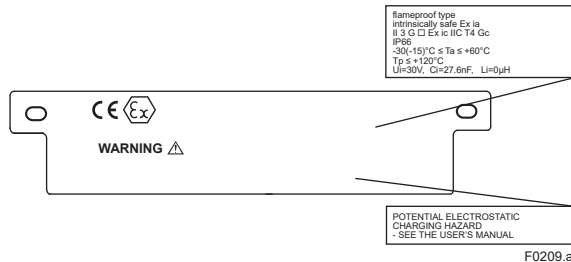

- MODEL: Specified model code.
- STYLE: Style code.
- SUFFIX: Specified suffix code.
- SUPPLY: Supply voltage.
- OUTPUT: Output signal.
- MWP: Maximum working pressure.
- CAL RNG: Specified calibration range.
- NO.: Serial number and year of production*1.
- TOKYO 180-8750 JAPAN:
- The manufacturer name and the address*2.

*1: The first digit in the three numbers next to the nine letters of the serial number appearing after "NO." on the nameplate indicates the year of production. The following is an example of a serial number for a product that was produced in 2010:

91K819857 032
 ↑
 The year 2010

*2: "180-8750" is a zip code which represents the following address.

2-9-32 Nakacho, Musashino-shi, Tokyo Japan

*3: The identification number of Notified Body.

2.9.4 IECEx Certification

EJX Series pressure transmitters with optional code /SU21 can be selected the type of protection (IECEx Intrinsically Safe Ex ia, Ex ic or flameproof) for use in hazardous locations.

Note 1. For the installation of this transmitter, once a particular type of protection is selected, any other type of protection cannot be used. The installation must be in accordance with the description about the type of protection in this instruction manual.

Note 2. For combined approval types, once a device of multiple approval type is installed, it should not be re-installed using any other approval types. Apply a permanent mark in the check box of the selected approval type on the certification label on the transmitter to distinguish it from unused approval types.

a. IECEx Intrinsically Safe Ex ia

Caution for IECEx Intrinsically safe Ex ia.

Note 1. EJX/EJA-E series pressure transmitters with optional code /SU21 are applicable for use in hazardous locations

- Applicable standards: IEC 60079-0, IEC 60079-11
- Certificate number: IECEx DEK 11.0081X
- Specific Ex marking: Ex ia IIC T4 Ga
- Ambient temperature: $-50^{\circ}\text{C} \leq T_a \leq +60^{\circ}\text{C}$
- Process temperature: $-50^{\circ}\text{C} \leq T_p \leq +120^{\circ}\text{C}$
- Enclosure: IP66/IP67 in accordance with IEC 60079-0
- Power supply: $\leq 30\text{ V}, \leq 21.6\text{ mA}$
- Dielectric strength: 500 V AC, r.m.s., Terminals: to Enclosure 1 min Supply + Supply -

Note 2. Specific condition of use

When the equipment is mounted in an area where the use of EPL Ga equipment is required, it shall be installed in such a way that, even in the event of rare incidents, an ignition source due to impact and/or friction sparks is excluded.

Precaution shall be taken to minimize the risk from electrostatic discharges or propagating brush discharges on the non-metallic parts (excluding glass parts) or coated parts of the equipment.

The dielectric strength of at least 500 V of the intrinsically safe circuits of the equipment is limited only by the overvoltage protection. From the safety point of view, the intrinsically safe circuit of the equipment shall be assumed to be connected to earth.

Note 3. Installation and erection

Cable entry devices suitable for the thread form and the size of the cable entries must be used, according to the following marking on the equipment.

Screw Size	Marking
ISO M20 × 1.5 female	⚠M
ANSI 1/2 NPT female	⚠A or ⚠N or ⚠W

F0218.ai

When installing the equipment, the selected Type of Protection should be ticked as follows.

- Ex ia IIC T4 Ga
- Ex ic IIC T4 Gc

See the control drawing.

Note 4. Use and setting-up (operation)

If the equipment is mounted in an area where explosive atmospheres may be present, it must be installed in such a way that the risk from electrostatic discharges and propagating brush discharges caused by rapid flow of dust are avoided.

Note 5. Maintenance and repair



A modification of the equipment would no longer comply with the construction described in the certificate documentation.
Only personnel authorized by Yokogawa Electric Corporation can repair the equipment.

Yokogawa Electric Corporation		Model		EJX Series	
Title Control drawing (General)					
No.	IKE045-A91	Page	1	Revision	0
				Date	2020-08-07

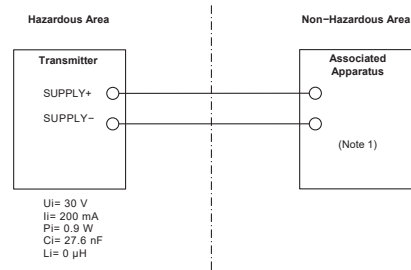

Notes:
1. Associated Apparatus must be a linear power source whose output current is resistively limited.

b. IECEx Intrinsically Safe Ex ic

Caution for IECEx Intrinsically safe Ex ic.

Note 1. EJX/EJA-E series pressure transmitters with optional code /SU21 are applicable for use in hazardous locations

- No. IECEx DEK 13.0061X
- Applicable Standard: IEC 60079-0:2011, IEC 60079-11:2011
- Ex ic IIC T4 Gc
- Ambient Temperature: -30* to 60°C
- * -15 °C when /HE is specified.
- Max. Process Temp.: 120°C
- IP Code: IP66
- Overvoltage Category: I

Note 2. Electrical Data

- Maximum Input Voltage (Ui) = 30 V
- Maximum Internal Capacitance (Ci) = 27.6 nF
- Maximum Internal Inductance (Li) = 0 μH

Note 3. Installation

- The pressure transmitter is allowed to be installed in “nL” systems, on condition that the output parameters of “nL” source (associated energy-limited apparatus) are suitable to the above mentioned input parameters of the pressure transmitter and the cable parameters.

- Cable glands, adapters and/or blanking elements shall be of Ex “n”, Ex “e” or Ex “d” and shall be installed so as to maintain the specified degree of protection of the equipment.
- The instrument modification or parts replacement by other than authorized representative of Yokogawa Electric Corporation is prohibited and will void IECEX certification.

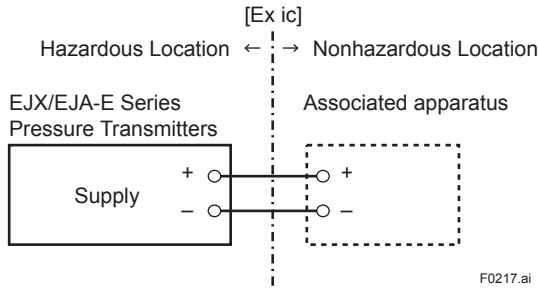

Note 4. Specific Condition of Use



WARNING

- Electrostatic charge may cause an explosion hazard. Avoid any actions that cause the generation of electrostatic charge, such as rubbing with a dry cloth on coating face of the product.
- The apparatus is not capable of dielectric strength tests required by IEC 60079-11. This must be taken into account when installing the apparatus.

c. IECEX Flameproof Type

Caution for IECEX flameproof type.

Note 1. EJX/EJA-E Series pressure transmitters with optional code /SF2 or /SU21 are applicable for use in hazardous locations:

- No. IECEX CSA 07.0008
- Applicable Standard: IEC60079-0:2011, IEC60079-1:2007-4
- Flameproof for Zone 1, Ex d IIC T6...T4 Gb
- Enclosure: IP66/IP67
- Maximum Process Temperature: 120°C (T4), 100°C (T5), 85°C (T6)
- Ambient Temperature: -50 to 75°C (T4), -50 to 80°C (T5), -50 to 75°C (T6)
- Supply Voltage: 42 V dc max. 32 V dc max. (FOUNDATION Fieldbus and PROFIBUS PA type) 9 to 28 V dc, 27 mW (Low Power type)

- Output Signal: 4 to 20 mA dc 15 mA (FOUNDATION Fieldbus and PROFIBUS PA type) 1 to 5 V (Low Power type)

Note 2. Wiring

- In hazardous locations, the cable entry devices shall be of a certified flameproof type, suitable for the conditions of use and correctly installed.
- Unused apertures shall be closed with suitable flameproof certified blanking elements.
- Wiring connection for output signal code Q (Low Power type) shall follow the diagram below.

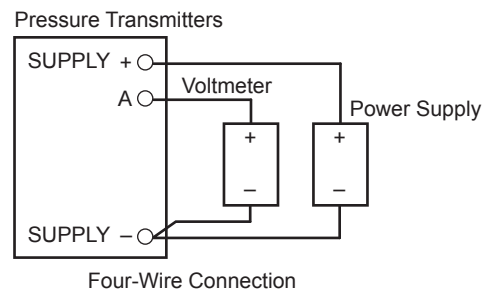
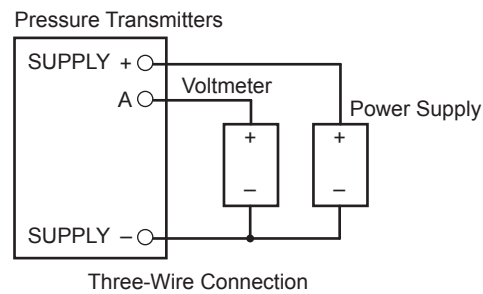

Note 3. Operation

- **WARNING:** AFTER DE-ENERGIZING, DELAY 5 MINUTES BEFORE OPENING.
- **WARNING:** WHEN THE AMBIENT TEMP. ≥ 65°C, USE HEAT-RESISTING CABLE AND CABLE GLAND ≥ 90°C.
- Take care not to generate mechanical sparking when accessing to the instrument and peripheral devices in a hazardous location.
- Electrostatic charge may cause an explosion hazard. Avoid any actions that cause the generation of electrostatic charge, such as rubbing with a dry cloth on coating face of the product.

Note 4. Maintenance and Repair

- The instrument modification or parts replacement by other than authorized representative of Yokogawa Electric Corporation is prohibited and will void IECEX Certification.
- Electrical Connection
A mark indicating the electrical connection type is stamped near the electrical connection port. These marks are as followed.

Screw Size	Marking
ISO M20 × 1.5 female	△ M
ANSI 1/2 NPT female	△ N or △ W

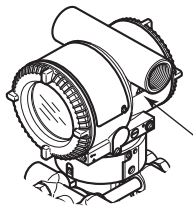

Location of the mark

F0215.ai

2.10 EMC Conformity Standards

EN 61326-1 Class A, Table2

EN 61326-2-3

EN 61326-2-5 (for Fieldbus)

Immunity influence during the test

Differential pressure / Pressure: Output shift is specified within ±1% of 1/20 Max span.

Static pressure: Output shift is specified within ±2% of 1 MPa span.

Status Output Line*: Continues to operate without reversal.

*: Only for /AL option.

Condition for EMC test for FOUNDATION fieldbus type: The shield of the cable and the case are connected with a capacitor of 10 nF.

CAUTION

To meet EMC regulations, Yokogawa recommends that customers run signal wiring through metal conduits or use shielded twisted-pair cabling when installing EJX/EJA-E series transmitters in a plant.

This equipment is a Class A product, and it is designed for use in the industrial environment. Please use this instrument in the industrial environment only.

2.11 Pressure Equipment Directive (PED)

(1) General

EJX/EJA-E Series pressure transmitters are categorized as piping under the pressure accessories section of directive 2014/68/EU, which corresponds to Article 4, Paragraph 3 of PED, denoted as Sound Engineering Practice (SEP).

(2) Technical Data

Article 4, Paragraph 3 of PED, denoted as Sound Engineering Practice (SEP).

(3) Operation

CAUTION

- The temperature and pressure of fluid should be maintained at levels that are consistent with normal operating conditions.
- The ambient temperature should be maintained at a level that is consistent with normal operating conditions.
- Please take care to prevent water hammer and the like from inducing excessive pressures in pipes and valves. If phenomena are likely, install a safety valve or take some other appropriate measure to prevent pressure from exceeding PS.
- Take appropriate measures at the device or system level to protect transmitters if they are to be operated near an external heat source.

2.12 EU RoHS Directive

Applicable standard: EN IEC 63000

Applicable production sites are shown below.
The condition of the RoHS compliant production sites are as follows:

Japan, Germany, Saudi Arabia, India

The production sites can be confirmed by the serial number shown in the frame of "NO." in the name plate of the product.

Serial numbers (9 letters): **AA**nnnnnnnn

AA: Identification code of production site

Japan: Use "91" or "90"

USA: Use "U1"

Germany: Use "D1"

Saudi Arabia: Use "Y3"

India: Use "Y1"

2.13 Safety Requirement Standards

Applicable standard: EN 61010-1, C22.2 No.61010-1

(1) Pollution Degree 2

"Pollution degree" describes the degree to which a solid, liquid, or gas which deteriorates dielectric strength or surface resistivity is adhering. "2" applies to normal indoor atmosphere. Normally, only non-conductive pollution occurs. Occasionally, however, temporary conductivity caused by condensation must be expected.

(2) Installation Category I

"Overvoltage category (Installation category)" describes a number which defines a transient overvoltage condition. It implies the regulation for impulse withstand voltage. "I" applies to electrical equipment which is supplied from the circuit when appropriate transient overvoltage control means (interfaces) are provided.

(3) Indoor/Outdoor use

It can be used in indoors and outdoors.

(4) Altitude of installation site

Max. 5,000 m above sea level

3. Component Names

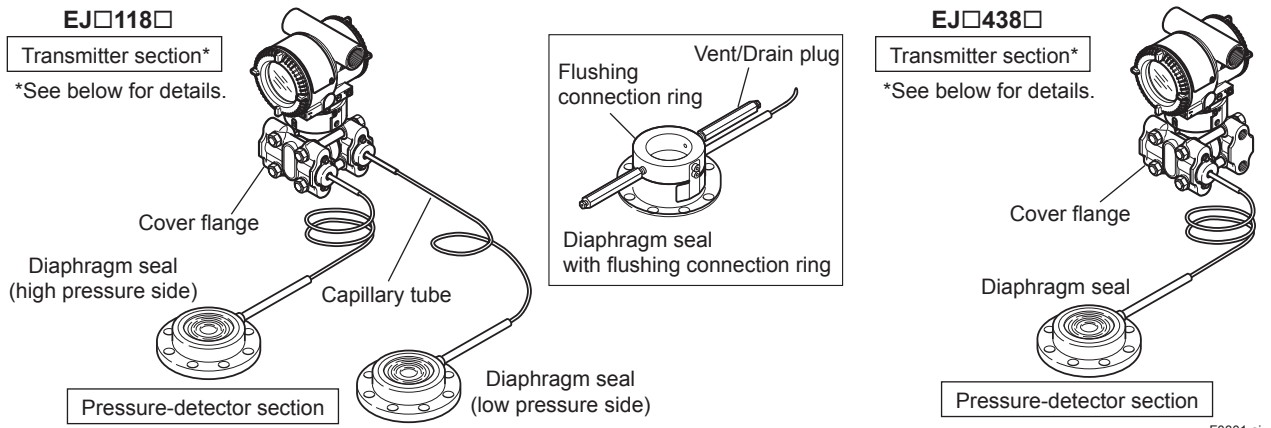
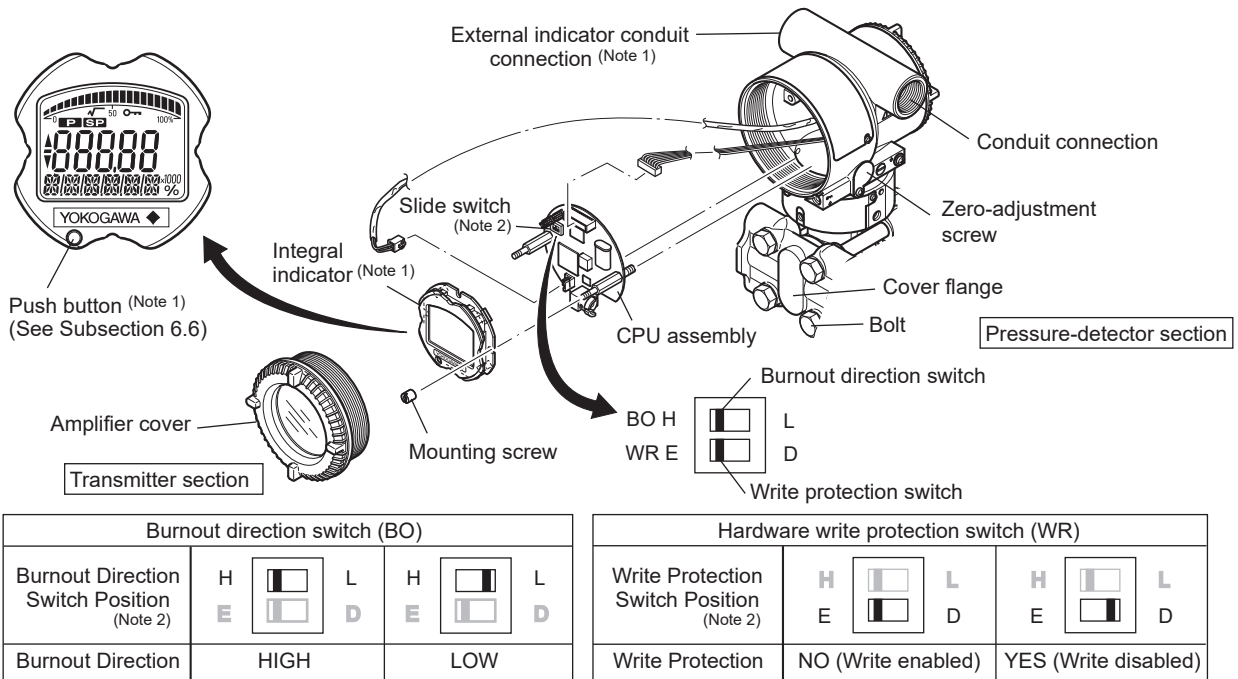

Figure 3.1 Component Names (External View of Flush type)



Note 1: See General Specifications sheet of each product for details.

Note 2: Applicable for BRAIN/HART communication type. Set the switches as shown in the figure above to set the burn-out direction and write protection. The Burnout switch is set to the H side for delivery (unless option code /C1 or /C2 is specified in the order), and the hardware write protection switch is set to E side. The setting of the switches can be confirmed via communication. An external zero adjustment screw can only be disabled by communication. To disable the screw, set a parameter before activating the hardware write protect function. See each communication manual for details.

Figure 3.2 Component Names (Transmitter Section Details)

Table 3.1 Display Symbol

Display Symbol	Meaning of Display Symbol
	Display mode is 'square root'. (Display is not lit when 'linear' mode.)
	The output signal being zero-adjusted is increasing. Besides, this symbol lights when local parameter setting is in progress.
	The output signal being zero-adjusted is decreasing. Besides, this symbol lights when local parameter setting is in progress.
	Write protect function is enabled.

F0303.ai

4. Installation

4.1 Precautions

Before installing the transmitter, read the cautionary notes in Section 2.4, "Selecting the Installation Location." For additional informations and limitations according to the selected model, suffix and option codes, please find information in each General Specifications sheet.



IMPORTANT

- When welding piping during construction, take care not to allow welding currents to flow through the transmitter.
- Do not step on this instrument after installation.
- For the EJ□438□, there is a small hole in the low pressure side cover flange that is used to measure the atmospheric pressure. The hole must not face upward.
- Never loosen the four bolts securing the cover flanges (Refer to figure 3.2.) If the seal liquid leaks, the transmitter cannot be used.

4.2 Mounting the Diaphragm Seals

Mount the diaphragm seals using the flanges as shown in Figure 4.1 Figure 4.2 shows how to mount the diaphragm seals on a tank. The mating flange, gasket, bolts and nuts are to be procured by the customer.

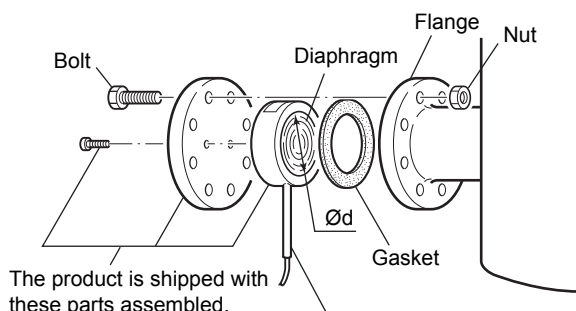

The product is shipped with these parts assembled.

Correctly install the diaphragm seals on the high and low pressure sides of the process (The label on each diaphragm seal is marked **HIGH** or **LOW**.)

F0401.ai

Figure 4.1 Mounting the Diaphragm Seals



IMPORTANT

Please use a gasket with an inside diameter (ϕd) that is greater than the diameter of the diaphragm seal. If a gasket with a smaller inside diameter is used, the diaphragm may not function correctly.



IMPORTANT

- When measuring the liquid level of the tank, the minimum liquid level (zero point) must be set to a level at least 50 mm above the center of the high pressure side diaphragm seal (see Figure 4.2).
- Correctly install the diaphragm seals on the high and low pressure sides of the process, checking the label on each seal.
- To avoid measuring error duets temperature difference between the two diaphragm seals, capillary tube must be bound together. The capillary tube must be securely fixed to the tank wall to prevent movement by wind or vibration. If the capillary tube is too long, loosely coil the extra tube portion (coil diameter of 300 mm or more) and secure the coiled tube with a clamp.
- During the diaphragm seal installation, ensure as far as possible that no seal liquid head pressure is applied to the diaphragm seals.
- Exercise care so as not to damage diaphragm surfaces. Since the diaphragm protrudes approx. 1 mm from the flange surface, do not place the pressure detector section face down on a surface as this can damage the diaphragm.
- Do not sharply bend or twist capillary tube or apply excessive stress to them.

IMPORTANT

Install the sealed diaphragm so that the shank positions downward.

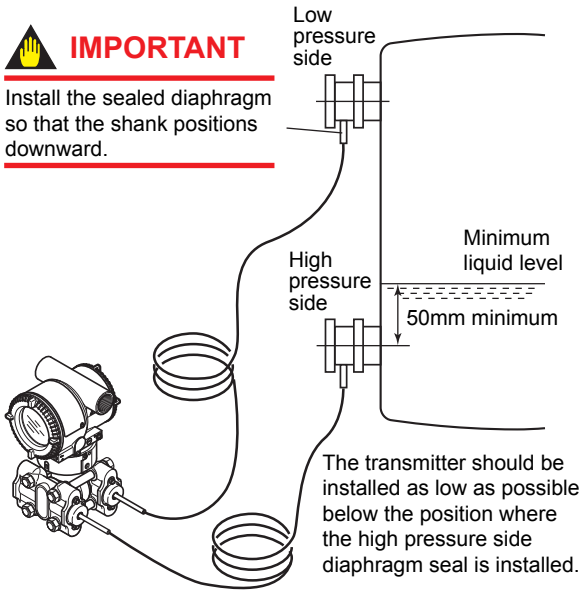

IMPORTANT

Install the sealed diaphragm so that the shank positions downward.

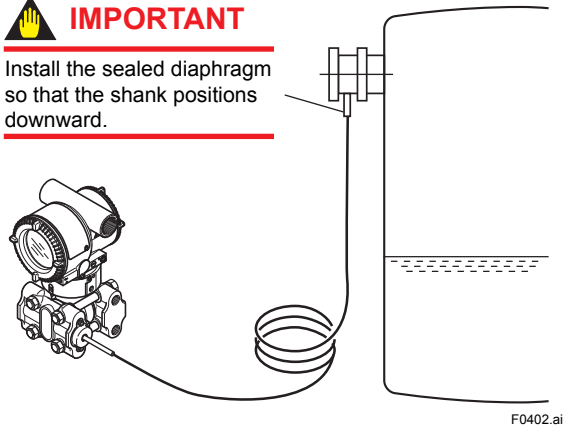

Figure 4.2 Installing the Diaphragm Seals to a Tank

F0402.ai

4.3 Transmitter Mounting

- The transmitter can be mounted on a nominal 50 mm (2-inch) pipe using the mounting bracket supplied, as shown in Figure 4.3. The transmitter can be mounted on either a horizontal or a vertical pipe.
- When mounting the bracket on the transmitter, tighten the (four) bolts that hold the transmitter to a torque of approximately 39 N·m {4 kgf·m}.

Horizontal pipe mounting

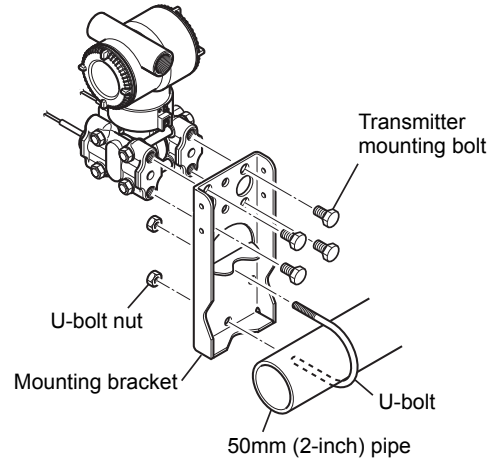

Vertical pipe mounting

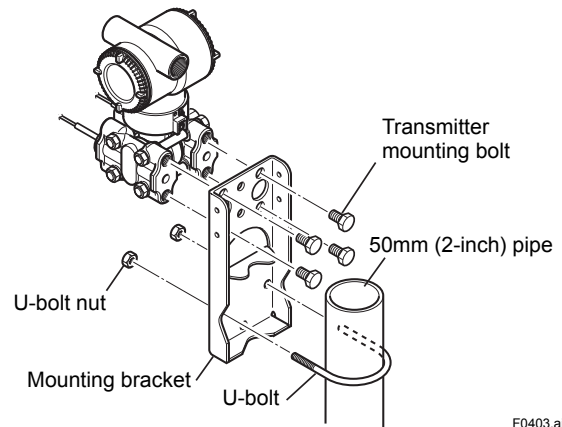

F0403.ai

Figure 4.3 Transmitter Mounting

IMPORTANT

Never loosen the four bolts securing the cover flange or the screws at the joints between the capillary tube and cover flanges (Refer to figure 3.2.) If the seal liquid leaks, the transmitter cannot be used.



IMPORTANT

The transmitter should be installed at least 600 mm below the high pressure (HP) process connection to ensure a positive head pressure of fill fluid. Pay special attention to vacuum applications. If it can not be installed at least 600 mm below the HP process connection, please use the equation below:

$$h = \frac{(P - P_0)}{ds} \times 0.102 \text{ [mm]}$$

- h: Vertical height between the HP process connection and the transmitter (mm)
- h ≤ 0: Install the transmitter at least h (mm) below the HP process connection
- h > 0: Install the transmitter at most h (mm) above the HP process connection

P: Pressure in the tank (Pa abs)

P0: Minimum working pressure limit of the transmitter (Pa abs). See below table.

[For fill fluid code A, B, C, D, E]

Wetted parts material code	Capillary length	Process connection size code		
		2, 8	3	4,W
SW	1 to 5 m	6790	3190	
	6 to 10 m	10030	3520	
SE	1 to 5 m		6790	3190
	6 to 10 m		10030	3520
SY	1 to 5 m			3190
	6 to 10 m			3520
HW	1 to 5 m	19150	6140	
	6 to 10 m		8290	
TW	1 to 5 m	9620	3620	
	6 to 10 m		4210	
UW	1 to 5 m	9540	4750	
	6 to 10 m		6050	

[For fill fluid code 1, 2, 4]

Wetted parts material code	Capillary length	Process connection size code		
		2, 8	3	4,W
SW	1 to 5 m	2570	320	
	6 to 10 m	4680	530	
SE	1 to 5 m		2570	320
	6 to 10 m		4680	530
SY	1 to 5 m			320
	6 to 10 m			530
HW	1 to 5 m	10220	2050	
	6 to 10 m		3450	
TW	1 to 5 m	4270	570	
	6 to 10 m		960	

ds: Specific gravity of fill fluid (at 25°C). See below table.

Fill fluid code	A, 1, 4	B	C, 2	D	E
ds: Specific gravity	1.07	0.94	1.09	1.90 to 1.92	1.09

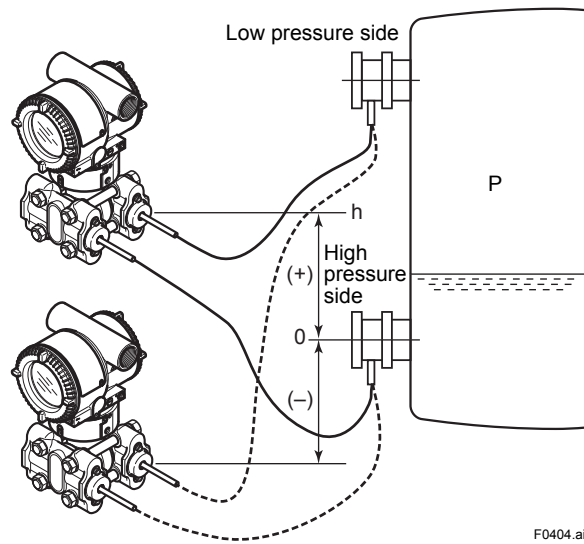

F0404.ai

Figure 4.4 Example of Installation to Tank for Differential Pressure Transmitter (Caution on Installation)

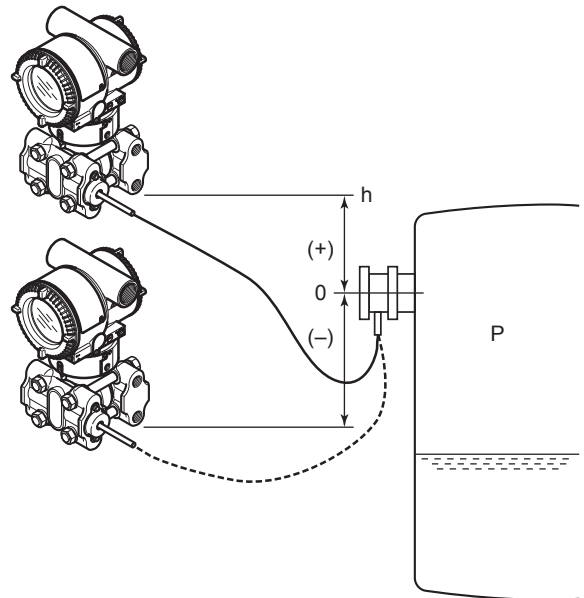

F0405.ai

Figure 4.5 Example of Installation to Tank for Gauge Pressure Transmitter (Caution on Installation)

4.4 Mounting the Flushing Connection Ring

4.4.1 Mounting to Pressure Detector Section

The flushing connection ring is mounted to the pressure detector section as shown in Figure 4.6. At the factory shipment, the flushing connection ring is already assembled and attached to process detector section.

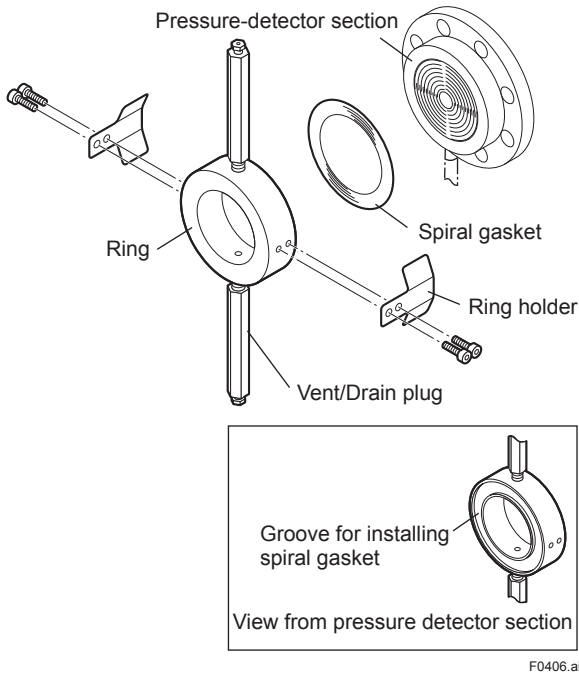

Figure 4.6 Mounting to Pressure Detector Section

- (1) Mount the ring holder on the ring and loosely tighten the mounting screws.
- (2) Place the spiral gasket in the ring groove. With the ring correctly aligned and flush with the face of the pressure detector, securely tighten each ring holder's mounting screws.
- (3) Position the ring so that the vent/drain plugs are aligned straight up and down.

4.4.2 Mounting to Process Flange

Tighten the bolts to completely close the gap between the ring and the pressure detector section. The mating flange, gasket, stud bolts and nuts are to be procured by the customer.

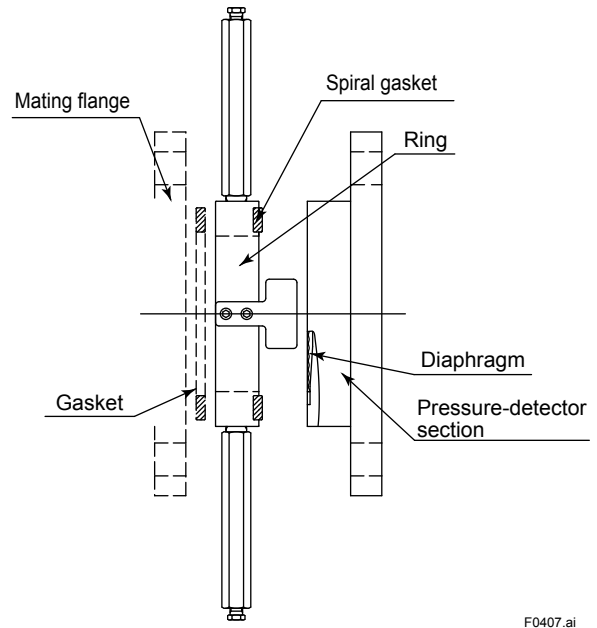

Figure 4.7 Mounting to Process Flange



IMPORTANT

- Confirm that there is no gap between the ring and the process-detector section after they are mounted on the process flange. A gap can lead to a sudden, explosive release of process fluids.
- When mounting or removing the ring, take care not to tilt the pressure detector downward as the ring can slip off and cause injury.
- When re-mounting the ring, use the new spiral gasket as shown in below table.

Table 4.1 Spiral Gasket for Pressure Detector Section Side*

Part number	Size	Description
F9350SV	ø100×ø120×t4.5	For 3-inch flange
F9970XF	ø100×ø120×t4.5	For 3-inch flange**
F9350ST	ø70×ø90×t4.5	For 2-inch flange
F9970XD	ø70×ø90×t4.5	For 2-inch flange**
F9346ZH	ø60×ø75×t4.5	For 1 1/2-inch flange
F9970XB	ø60×ø75×t4.5	For 1 1/2-inch flange**

*: Material; 316SST (Hoop), PTFE Teflon (Filler)

** : For oil-prohibited use (Option code: /K1, /K2, /K5, /K6)

4.5 Affixing the Teflon Film

The FEP Teflon option includes a teflon film and fluorinated oil.

Before mounting the diaphragm seal to the process flange, affix the teflon film as follows:



IMPORTANT

- 1) Position the diaphragm seal so that the diaphragm is in an upward position.
- 2) Pour the fluorinated oil on the diaphragm and gasket area covering it completely and evenly. Be careful not to scratch the diaphragm or change its shape.
- 3) Affix the teflon film over the diaphragm and gasket area.
- 4) Next, carefully inspect the cover and try to identify any entrapped air between the diaphragm and the teflon film. The air must be removed to ensure optimum performance. If air pockets are present, use your fingers to remove the air by starting at the center of the diaphragm and work your way out.
- 5) Position the gasket on the Teflon film.
- 6) Mount the transmitter onto the process flange.

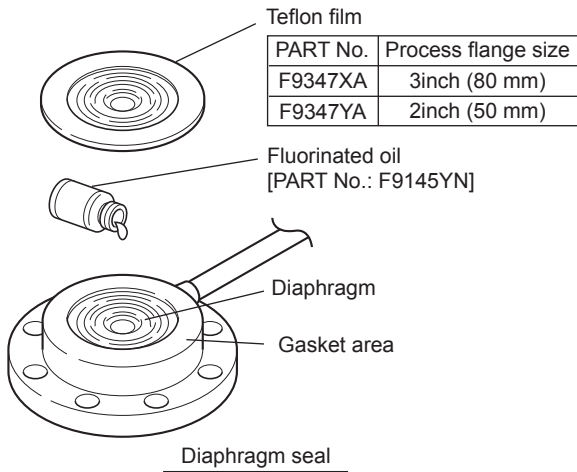

Figure 4.8 Affixing the Teflon Film

F0408.ai

4.6 Rotating Transmitter Section

The transmitter section can be rotated approximately 360° and can be fixed at any angle within the above range. (The direction of the rotation is depending on the configuration of the instrument.) Note that there is a stopper which prevents the transmitter section from being rotated more than 360°.

- (1) Using the Allen wrench, remove the two setscrews securing the transmitter section to the capsule assembly.
- (2) Rotate the transmitter section slowly to the desired position.
- (3) Tighten the two setscrews to a torque of 1.5 N·m {15 kgf·cm}.



WARNING

In the case of the explosion-proof/flameproof type transmitter, do not rotate the transmitter part in the hazardous area while the transmitter is energized.



IMPORTANT

Do not rotate the transmitter section more than the above limit.

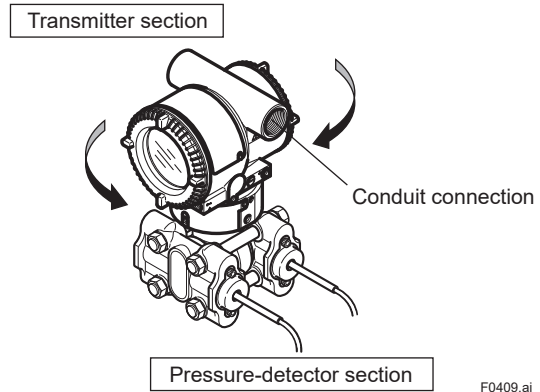

F0409.ai

Figure 4.9 Rotating Transmitter Section

4.7 Changing Integral Indicator Direction



IMPORTANT

- Always turn OFF power and shut off and release pressures before disassembly.
- For changing the integral indicator direction, the transmitter must be removed to a non-hazardous area.

An integral indicator can be installed in the following three directions, Refer to subsection 7.4 for attaching and removing the integral indicator.

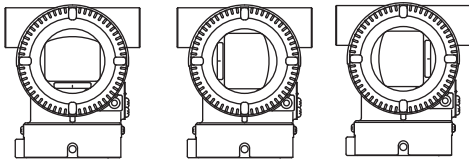

F0410.ai

Figure 4.10 Integral Indicator Direction

5. Wiring

5.1 Wiring Precautions



IMPORTANT

- Lay wiring as far as possible from electrical noise sources such as large capacity transformers, motors, and power supplies.
- Remove the electrical connection dust cap before wiring.
- All threaded parts must be treated with waterproofing sealant. (A non-hardening sealant is recommended.)
- To prevent noise pickup, do not pass signal and power cables through the same ducts.
- Explosion-protected instruments must be wired in accordance with specific requirements (and, in certain countries, legal regulations) in order to preserve the effectiveness of their explosion-protected features.
- The terminal box cover is locked by an Allen head bolt (a shrouding bolt) on ATEX flameproof type transmitters. When the shrouding bolt is driven clockwise using an Allen wrench, it goes in. The cover lock can then be released and the cover can be opened by hand. See subsection 7.4 “Disassembly and Reassembly” for details.
- Plug and seal an unused conduit connection.

5.2 Selecting the Wiring Materials

- Use stranded leadwires or cables which are the same as or better than 600 V grade PVC insulated wire (JIS C3307) or its equivalent.
- Use shielded wires in areas that are susceptible to electrical noise.
- In areas with higher or lower ambient temperatures, use appropriate wires or cables.
- In environment where oils, solvents, corrosive gases or liquids may be present, use wires or cables that are resistant to such substances.
- It is recommended that crimp-on solderless terminal lugs (for 4 mm screws) with insulating sleeves be used for leadwire ends.

5.3 Connections of External Wiring to Terminal Box

• Terminal Configuration

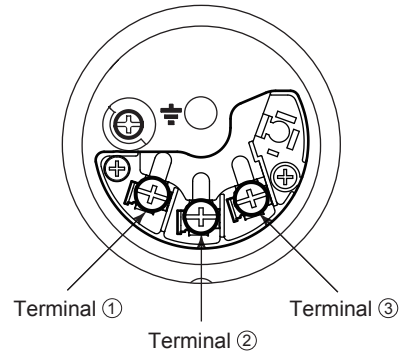

F0513.ai

• Terminal Wiring for 4 to 20 mA output, FOUNDATION Fieldbus type, and PROFIBUS PA type.

SUPPLY	+	①	Power supply and output terminals
	-	②	
CHECK	+	③	External indicator (ammeter) terminals ^{*1,2} or
or	-	②	
ALARM	+	③	Status contact output terminals ² (when /AL is specified)
	-	②	
			⏏ Ground terminal

*1: When using an external indicator or check meter, the internal resistance must be 10 Ω or less. A check meter or indicator cannot be connected when /AL option is specified.

*2: Not available for FOUNDATION Fieldbus and PROFIBUS PA communication types.

• Terminal Wiring for 1 to 5 V output

SUPPLY	+	①	Power supply terminals
	-	②	
VOUT	+	③	1 to 5 V DC with HART communication terminals
	-	②	
			⏏ Ground terminal

F0514.ai

Figure 6.1 Terminal

5.3.1 Power Supply Wiring Connection



IMPORTANT

Connecting with the commercial AC power supply will damage the device. Be sure to use the DC power supply in the predetermined range.

Connect the power supply wiring to the SUPPLY + and – terminals. When /AL is specified, also refer to subsection 5.3.5.

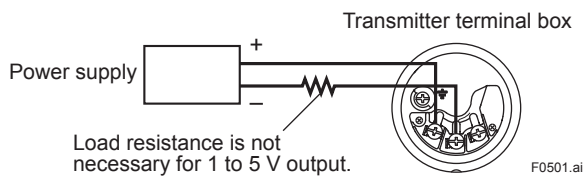

Figure 5.2 Power Supply Wiring Connection

5.3.2 External Indicator Connection

Available only for 4 to 20mA output type and when /AL is not specified.

Connect wiring for external indicators to the CHECK (+) and SUPPLY – terminals.

(Note) Use an external indicator whose internal resistance is 10 Ω or less.

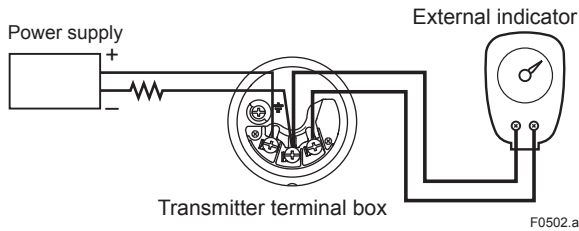

Figure 5.3 External Indicator Connection

5.3.3 Communicator Connection

- 4 to 20 mA output, BRAIN / HART



IMPORTANT

Analog output may change temporarily in connecting with BRAIN terminal due to an initial current flowed to it. To prevent communication signal affecting the upper system, it is recommended to install a low-pass filter (approximately 0.1s)

Connect the BT200 or HART Communicator to the SUPPLY + and – terminals. (Use hooks.)

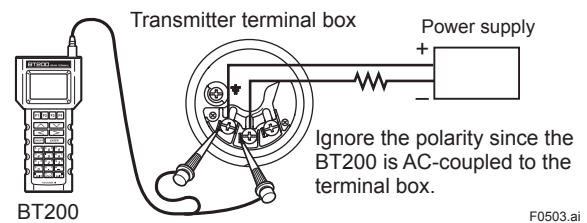

Figure 5.4 BT200 Connection

- 1 to 5 V output, HART

Connect the HART communicator or configuration tool to the SUPPLY - and VOUT (+) terminals. (Use hooks.)

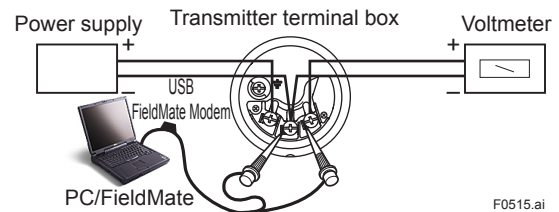

Figure 5.5 Four wire connection

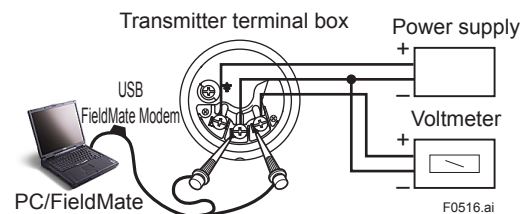

Figure 5.6 Three wire connection

5.3.4 Check Meter Connection

Available only for 4 to 20mA output type and when /AL is not specified.

Connect the check meter to the CHECK (+) and SUPPLY – terminals. (Use hooks.)

- A 4 to 20 mA DC output signal from the CHECK (+) and SUPPLY – terminals.

(Note) Use a check meter whose internal resistance is 10 Ω or less.

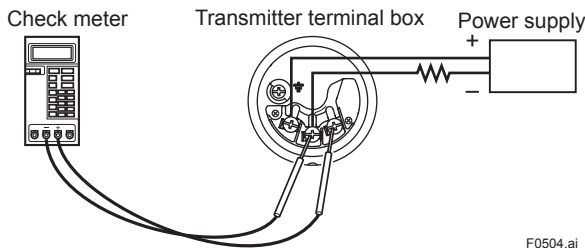

Figure 5.7 Check Meter Connection

5.3.5 Status Output Connection

When option code /AL is specified, connect the external wiring as shown in Figure 5.5.

To configure and activate the process alarm function and status output, it is necessary to set some parameters. Refer to each communication manual for procedures.

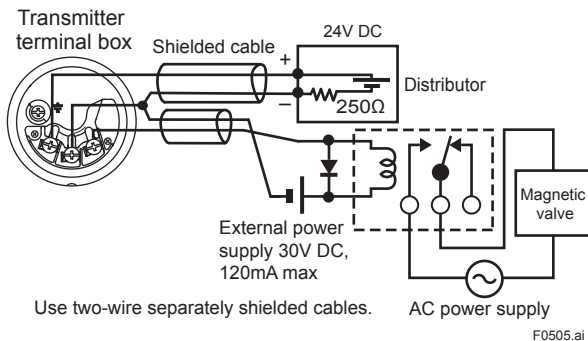

Figure 5.8 Status Output Connection

5.4 Wiring

5.4.1 Loop Configuration

Since the DPharp uses a two-wire transmission system for 4 to 20 mA output, signal wiring is also used as power wiring.

DC power is required for the transmitter loop. The transmitter and distributor are connected as shown below.

For details of the power supply voltage and load resistance, see section 5.6.

For 1 to 5 V output, three or four wire system is used. See (3).

(1) 4 to 20 mA output, General-use Type and Flameproof Type

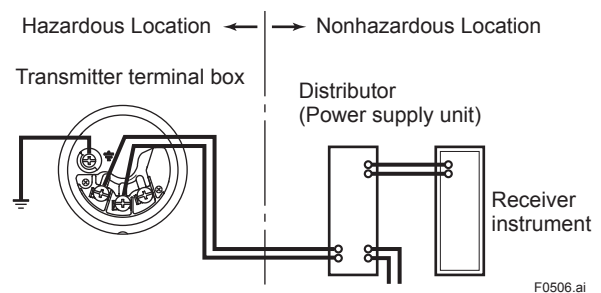

Figure 5.9 Connection between Transmitter and Distributor

(2) 4 to 20 mA output, Intrinsically Safe Type

With the intrinsically safe type, a safety barrier must be included in the loop.

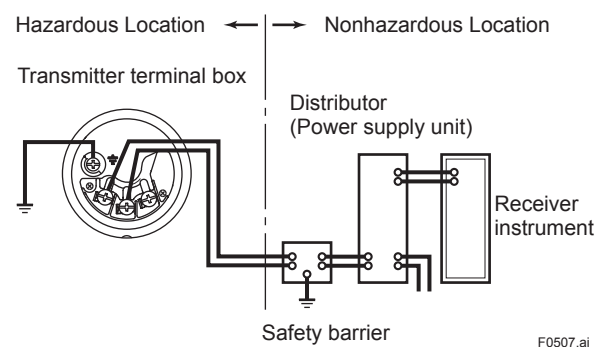

Figure 5.10 Connection between Transmitter and Distributor

(3) 1 to 5 V output

Either three or four wire system is used.

Power supply line and 1 to 5 V signal line commonly use the SUPPLY - terminal.



NOTE

With three wire connection, the cable length may affect the measurement accuracy of the output signal.

In either three-wire or four-wire connection, recommended wiring distance is 200 m or less, and the use of shielded cable is recommended.

- Three wire connection
For three wire system, a negative wiring shall be commonly used for power supply and signal line.

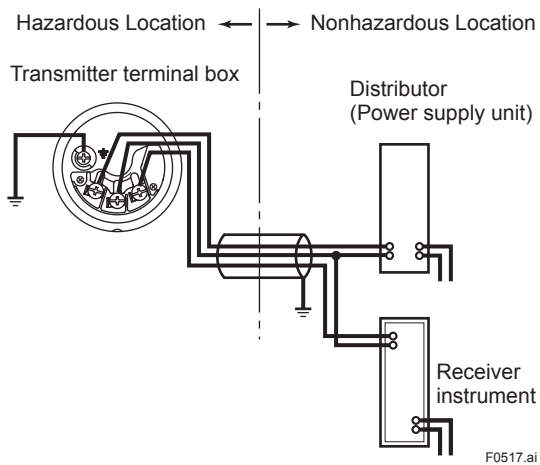

Figure 5.11 Connection between Transmitter, Distributer and Receiver

- Four wire connection
Fasten the negative side wiring of both power supply and signal line to the SUPPLY - terminal.

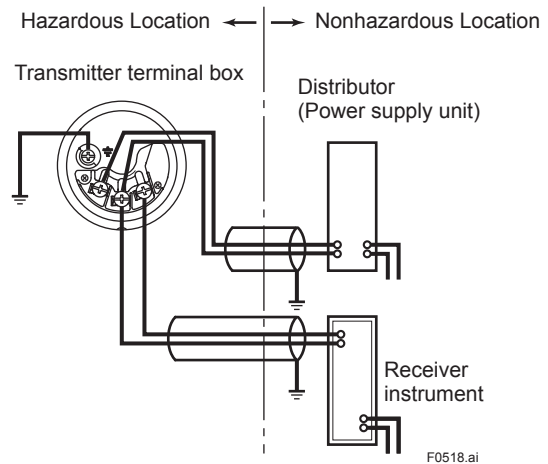

Figure 5.12 Connection between Transmitter, Distributer and Receiver

5.4.2 Wiring Installation

(1) General-use Type and Intrinsically Safe Type

With the cable wiring, use a metallic conduit or waterproof glands.

- Apply a non-hardening sealant to the terminal box connection port and to the threads on the flexible metal conduit for waterproofing.

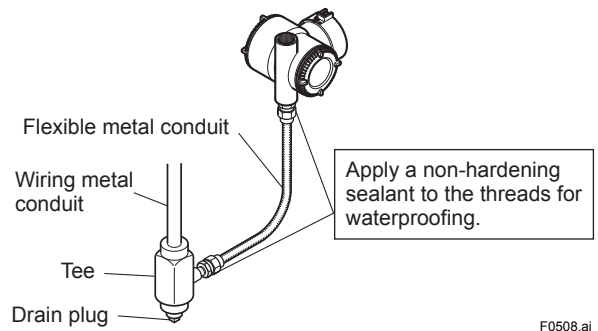

Figure 5.13 Typical Wiring Using Flexible Metal Conduit

(2) Flameproof Type

Wire cables through a flameproof packing adapter, or use a flameproof metal conduit.

- Wiring cable through flameproof packing adapter.

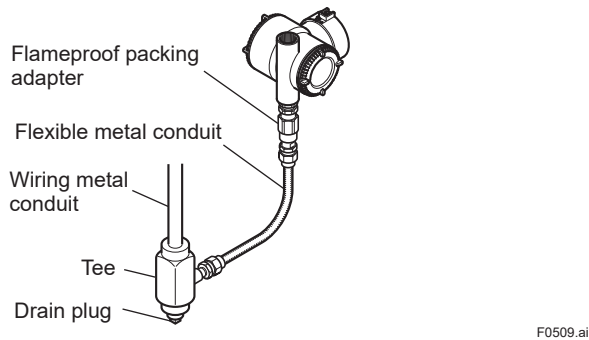

Figure 5.14 Typical Cable Wiring Using Flameproof Packing Adapter

- Flameproof metal conduit wiring
 - A seal fitting must be installed near the terminal box connection port for a sealed construction.
 - Apply a non-hardening sealant to the threads of the terminal box connection port, flexible metal conduit and seal fitting for waterproofing.

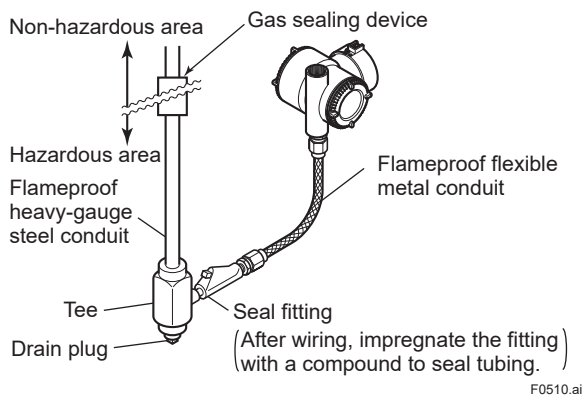

Figure 5.15 Typical Wiring Using Flameproof Metal Conduit

5.5 Grounding

Grounding is always required for the proper operation of transmitters. Follow the domestic electrical requirements as regulated in each country. For a transmitter with a built-in lightning protector, grounding should satisfy ground resistance of 10Ω or less.

Ground terminals are located on the inside and outside of the terminal box. Either of these terminals may be used.

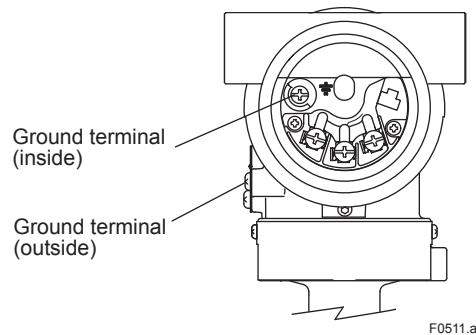

Figure 5.16 Ground Terminals

5.6 Power Supply Voltage and Load Resistance

For 4 to 20 mA output only.

When configuring the loop, make sure that the external load resistance is within the range in the figure below.

(Note) In case of an intrinsically safe transmitter, external load resistance includes safety barrier resistance.

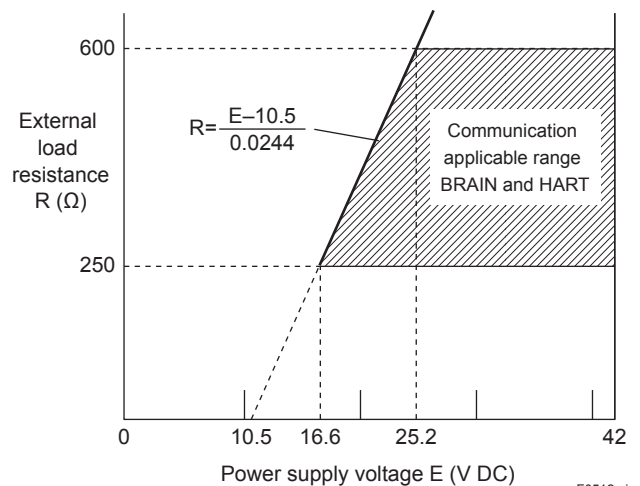

Figure 5.17 Relationship between Power Supply Voltage and External Load Resistance

6. Operation

6.1 Preparation for Starting Operation

This section describes the operation procedure for the EJ□118□ as shown in Figure 6.1 when measuring liquid level in a closed tank, and EJ□438□ as shown in Figure 6.2 when measuring pressure in a tank.

- (a) Confirm that there is no leak in the connecting part of each diaphragm seal mounting flange.
 - (b) Turn ON power and connect the communicator. Open the terminal box cover and connect the communicator to the SUPPLY + and – terminals.
 - (c) Using the communicator, confirm that the transmitter is operating properly. Check parameter values or change the setpoints as necessary.
- See IM 01C25T03-01E (BRAIN communication) or IM 01C25T01-06EN (HART communication) for communicator operation. If the transmitter is equipped with an integral indicator, its indication can be used to confirm that the transmitter is operating properly.

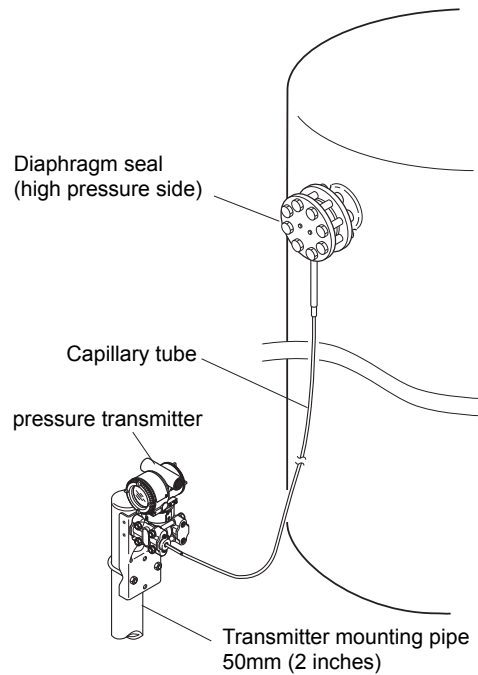

F0602.ai

Figure 6.2 Pressure Measurement

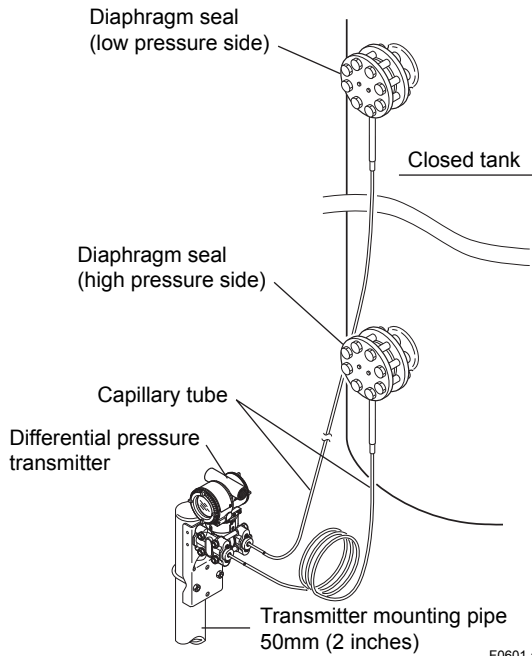

F0601.ai

Figure 6.1 Liquid Level Measurement in a Closed Tank

■ **Confirming that Transmitter is Operating Properly**

Using the BT200



IMPORTANT

- Analog output may change temporally in connecting with BRAIN terminal due to an initial current flowed to it. To prevent communication signal affecting the upper system, it is recommended to install a low-pass filter (approximately 0.1s).
- Communication signal is superimposed on analog output signal. It is recommended to set a low-pass filter (approximately 0.1s) to the receiver in order to reduce the output effect from communication signal. Before online-communication, confirm that communication signal does not give effect on the upper system.

- If the wiring system is faulty, 'communication error' appears on the display.
- If the transmitter is faulty, 'SELF CHECK ERROR' appears on the display.

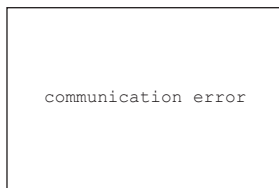

Communication error (Faulty wiring)

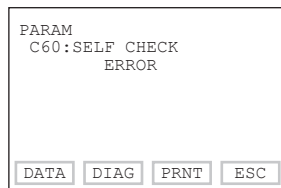

Self-diagnostic error (Faulty transmitter)

F0603.ai

Using the integral indicator

- If the wiring system is faulty, the display stays blank.
- If the transmitter is faulty, an error code is displayed.



Self-diagnostic error on the integral indicator (Faulty transmitter)

F0604.ai



NOTE

If any of the above errors are indicated on the display of the integral indicator or the communicator, refer to subsection 7.5.3 for corrective action.

■ **Verify and Change Transmitter Parameter Setting and Values**

The parameters related to the following items are set at factory as specified by the customer.

- Calibration range
- Integral indicator display
- Output mode
- Software damping (optional)

Other parameters like following are shipped with the default setting.

- Low-cut
- Process alarm setting
- Static pressure range
- Signal characterizer
- Write protection

To confirm or change the values, see IM 01C25T01-06EN or 01C25T03-01E.

6.2 Zero Point Adjustment

After completing preparations for operating the transmitter, adjust the zero point.

Zero point adjustment can be done by turning the transmitter's zero-adjustment screw or by using the communicator. This section describes the procedure for the zero-adjustment screw. For the communicator procedure, see the communication manual.



IMPORTANT

Do not turn off the power to the transmitter immediately after performing a zero point adjustment. Powering off within 30 seconds of performing this procedure will return the zero point to its previous setting.



NOTE

Before performing this adjustment, make sure that the external zero adjustment function has NOT been disabled by a parameter setting.



NOTE

Because the output value may be affected by the transmitter's mounting position, zero adjustment should be executed after installing the transmitter. If you have to adjust zero point before installation, make the posture of the transmitter close to the actual installation state when adjusting zero.

To check the output signal, use a digital multimeter, calibrator, or communicator.

- (1) **When you can obtain the Low Range Value from the actual measured value of 0% (0 kPa, atmospheric pressure);**

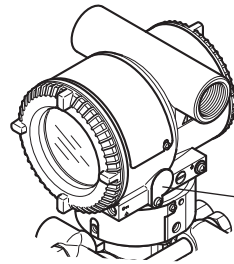

Zero-adjustment screw cover

F0605.ai

The zero-adjustment screw is located inside the cover.

Use a slotted screwdriver to turn the zero-adjustment screw. Turn the screw clockwise to increase the output or counterclockwise to decrease the output. The zero point adjustment can be made with a resolution of 0.01% of the setting range. The degree of zero adjustments varies with the screw turning speed; turn the screw slowly to make a fine adjustment, quickly to make a rough adjustment.

When adjusting the transmitter zero point, the liquid level in a tank does not have to be set to the low limit (0%) of the measuring range; use a digital manometer or a glass gauge to match the transmitter output signal with the actual measured value.

- (2) **When you cannot obtain the Low Range Value from the actual measured value of 0%;**

Adjust the transmitter output to the actual measured value obtained by a digital manometer or a glass gauge.

[Example]

The measuring range of 50 to 250 kPa; the actual measured value of 130 kPa.

$$\text{Actual measured value} = \frac{130-50}{250-50} \times 100 = 40.0\% \quad (=10.4\text{mA})$$

Turn the screw to match the output signal to the actual measured value.

6.3 Starting Operation

After completing the zero point adjustment, follow the procedure below to start operation.

- 1) Confirm the operating status. If the output signal exhibits wide fluctuations (hunting) due to periodic variation in the process pressure, use the communicator to dampen the transmitter output signal. Confirm the hunting using a receiving instrument or the integral indicator, and set the optimum damping time constant.
- 2) After confirming the operating status, perform the following:



IMPORTANT

- Remove the communicator from the terminal box, and confirm that none of the terminal screws are loose.
- Close the terminal box cover and the amplifier cover. Screw each cover in tightly until it will not turn further.
- There are two covers that must be locked on the ATEX Flameproof type transmitters. An Allen head bolt (shrouding bolt) under the edge of each cover is used to lock the cover. When the shrouding bolt is driven counterclockwise with an Allen wrench, the bolt rotates upward and locks the cover. (See page 7-3.) After locking the covers, confirm that they are secure and cannot be opened by hand.
- Tighten the zero-adjustment cover mounting screw to secure the cover.

6.4 Shutting Down Operation

Turn off the power.



NOTE

Whenever shutting down the transmitter for a long period, detach the transmitter (diaphragm seals) from the tank.

6.5 Venting or Draining Transmitter Process-Detector Section

If condensate (or gas) collects in the transmitter process-detector section, the measured pressure may be in error. If it is not possible to configure the piping for self draining (or self-venting) operation, you will need to loosen the drain (vent) screw on the flushing connection ring to completely drain (vent) any stagnated liquid (gas).

However, since draining condensate or bleeding off gas gives the pressure measurement disturbance, this should not be done when the loop is in operation.



WARNING

Since the accumulated liquid (or gas) may be toxic or otherwise harmful, take appropriate care to avoid contact with the body, or inhalation of vapors.

6.5.1 Draining Condensate for Flushing Connection Ring

- 1) Gradually open the drain screw to drain from the flushing connection ring.
- 2) When the flushing connection ring is completely drained, close the drain screw.
- 3) Tighten the drain screw to a torque of 10 N·m {1 kgf·m}.

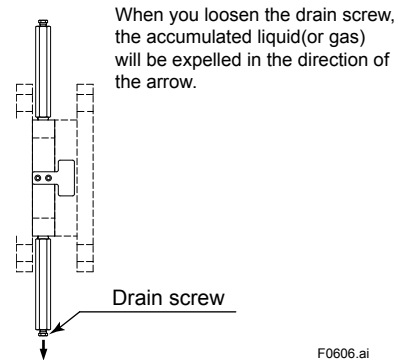

Figure 6.3 Draining for Flushing Connection Ring

6.5.2 Venting Gas for Flushing Connection Ring

- 1) Gradually open the vent screw to vent gas from the flushing connection ring.
- 2) When the flushing connection ring is completely vented, close the vent screw.
- 3) Tighten the vent screw to a torque of 10 N·m {1 kgf·m}.

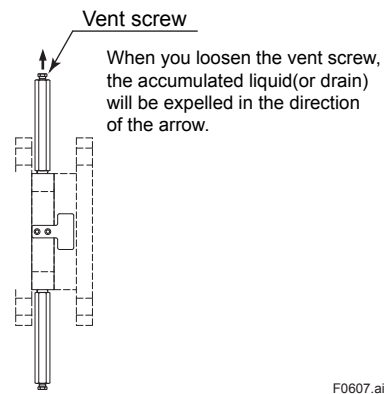

Figure 6.4 Venting for Flushing Connection Ring

6.6 Local Parameter Setting



WARNING

The local push button on the integral indicator must not be used in a hazardous area. When it is necessary to use the push button, operate it in a non-hazardous location. In the case of the explosion-proof/flameproof type transmitter, please refer to section 2.9 for each product.



IMPORTANT

- Do not turn off the power to the transmitter immediately after performing parameter setting. Powering off within 30 seconds of performing this procedure will return the parameter to its previous setting.
- The parameters of Ext SW for HART or J55:EXT ZERO ADJ for BRAIN, to enable or inhibit zero point adjustment by means of the zero-adjustment screw on the transmitter must be “Enabled” to perform this configuration. Please refer to either IM 01C25T01-06EN for the HART communication type, or IM 01C25T03-01E for the BRAIN communication type for the setting procedure.
- The Local Parameter Setting function is available with HART or BRAIN communication type.
LCD update will be slower at low ambient temperature, and it is recommended to use LPS function at temperatures above -10 degrees C.

6.6.1 Local Parameter Setting (LPS) Overview

Parameter configuration by the zero-adjustment screw and push button (integral indicator code E) offers easy and quick setup for parameters of Loop test, Tag number, Unit, LRV, URV, Damping, Output mode (linear/square root), Display out 1, and Re-range by applying actual pressure (LRV/URV) and Device Information. There is no effect on measurement signal (analog output or communication signal) when Local Parameter Setting is carried out.

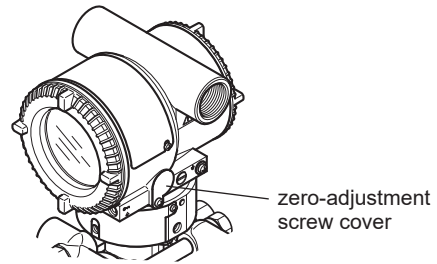

F0608.ai

Figure 6.5 Zero-adjustment Screw

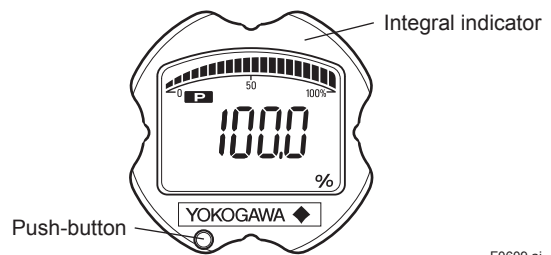

F0609.ai

Figure 6.6 Range-Setting Switch (push button)

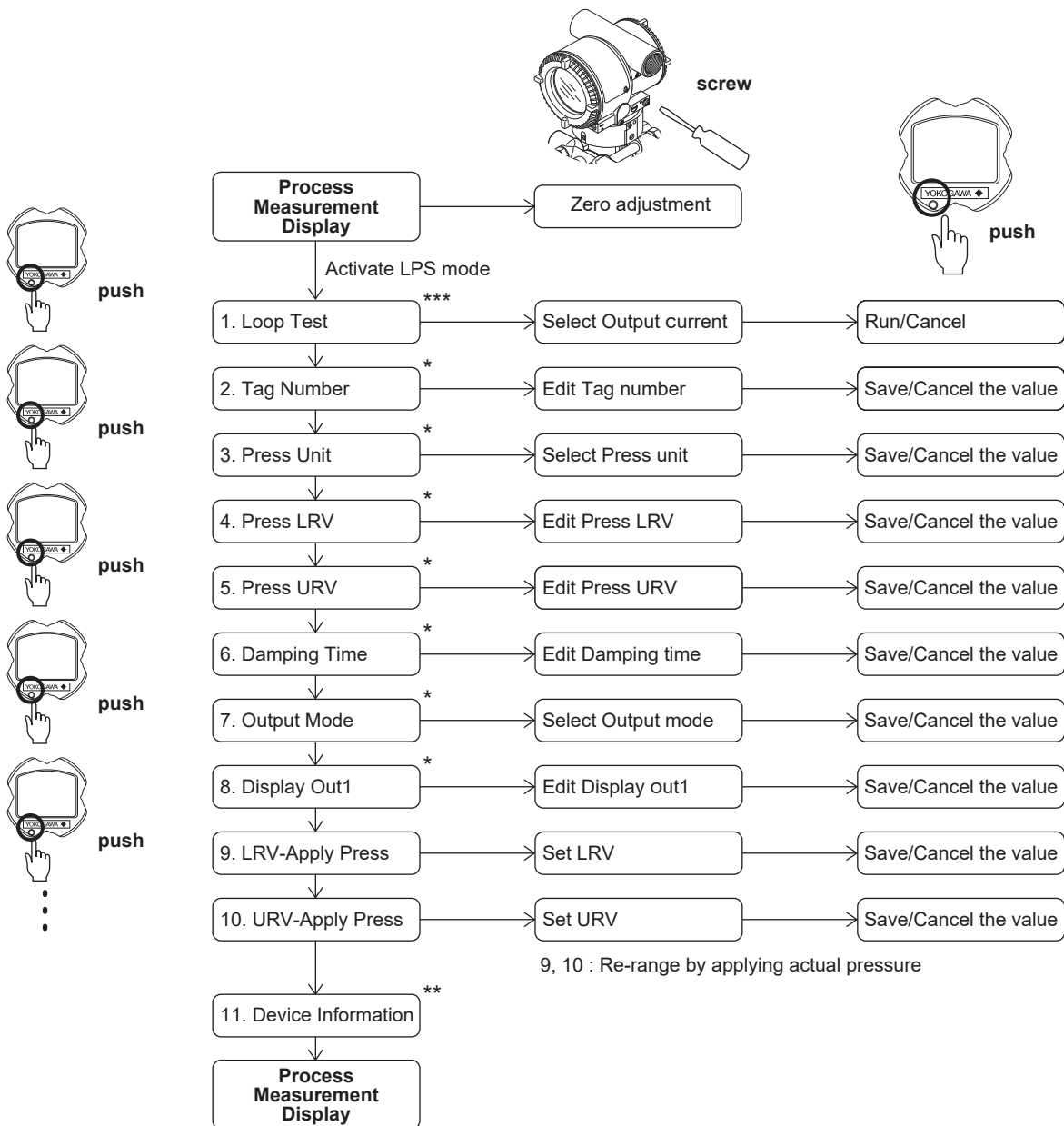

F0610.ai

- *: These parameter configurations are available with the software revision (SOFT REV)2.03 or later. Software revision can be checked via a field communicator (HART/BRAIN) or DTM. Please refer to IM 01C25T01 for HART parameter "Software rev" and IM 01C25T03 for BRAIN "SOFT REV."
- ** : This parameter configuration is available with the software revision (SOFT REV) 3.01 or later.
- ***: This parameter configuration is available with the software revision (SOFT REV) 5.01 or later.

6.6.2 Activating Local Parameter Setting

Press the push button on the integral indicator to activate the Local Parameter Setting mode. The transmitter will exit automatically from the Local Parameter Setting mode if no operation is carried out for 10 minutes.

6.6.3 Parameter Setting Review

Current setting value for the below parameters are shown sequentially by each press of the push button. Loop test, Tag number, Unit, LRV, URV, Damping, Output mode (linear/square root), Display out 1, Re-range by applying actual pressure (LRV/URV) and Device Information.

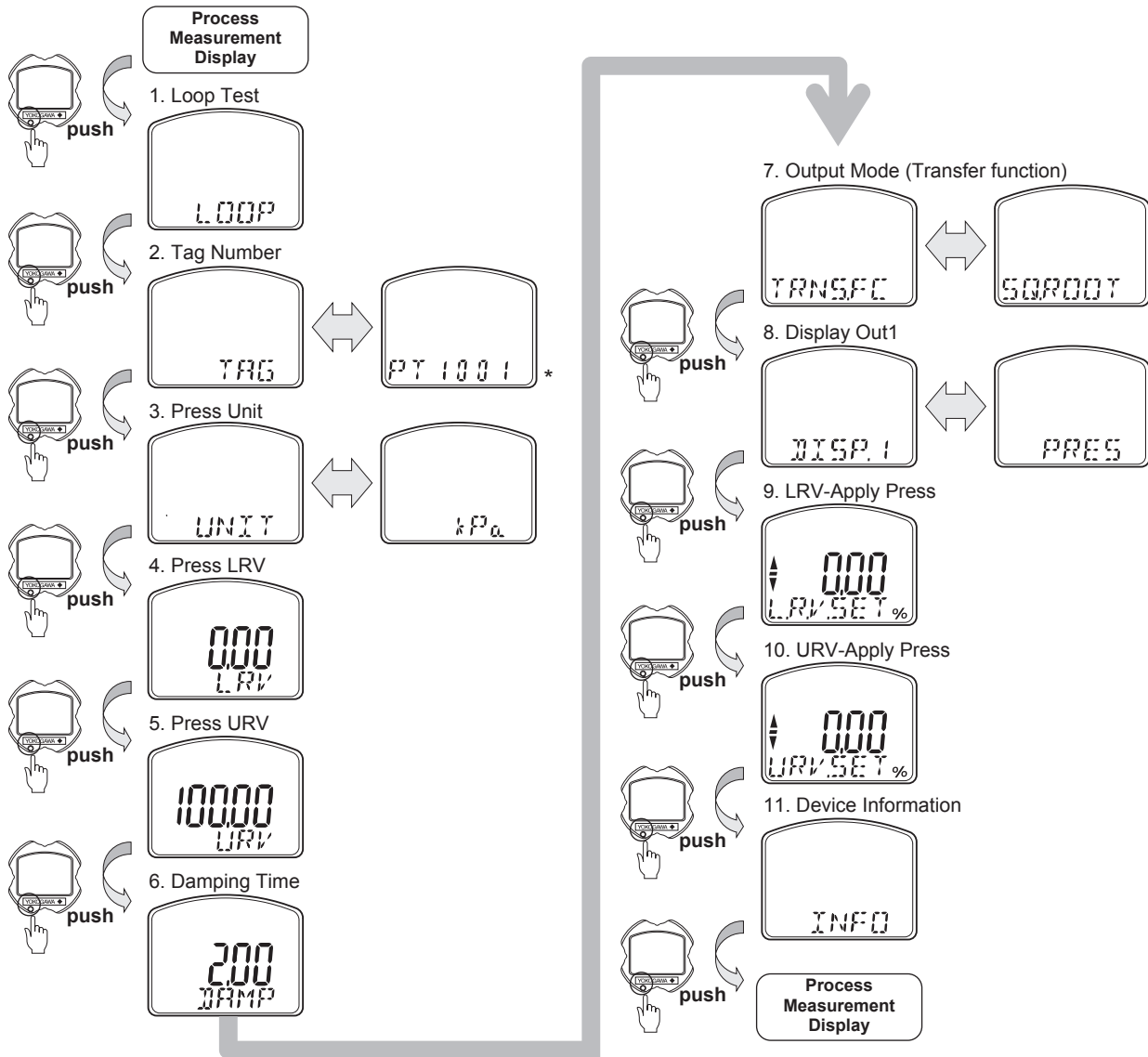

F0611.ai

*: [Software revision: 2.03] Up to 6 characters are shown in the bottom line. To review after the 7th character, turn the zero-adjustment screw and press the push button six times or more.
[Software revision: 3.01 or later] The display automatically scrolls to show all the characters.

To configure each parameter value, turn the zero-adjustment screw on each parameter screen after activating the Local Parameter Setting mode.

To cancel the Local Parameter Setting configuration, please refer to 6.6.13 Save or Cancel and 6.6.14 Abort Configuration.

6.6.4 Loop Test Configuration

Loop test configuration can be changed as below. Output current value (4 mA, 12 mA or 20 mA) for Loop test can be selected by turning the zero-adjustment screw.

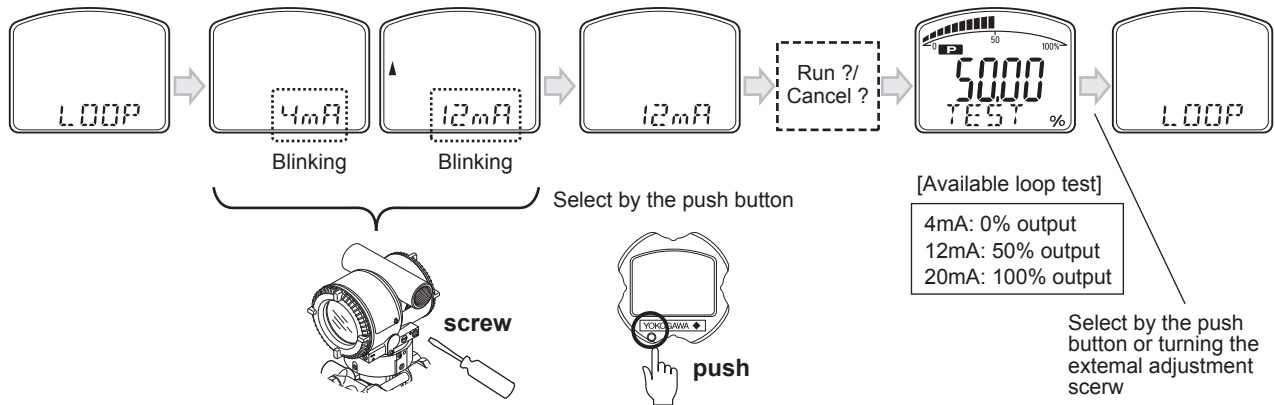

F0619.ai

6.6.5 Tag Number Configuration

Tag Number is edited by turning the zero-adjustment screw. Up to 8 alphanumeric characters for HART or 16 alphanumeric characters for BRAIN can be set.

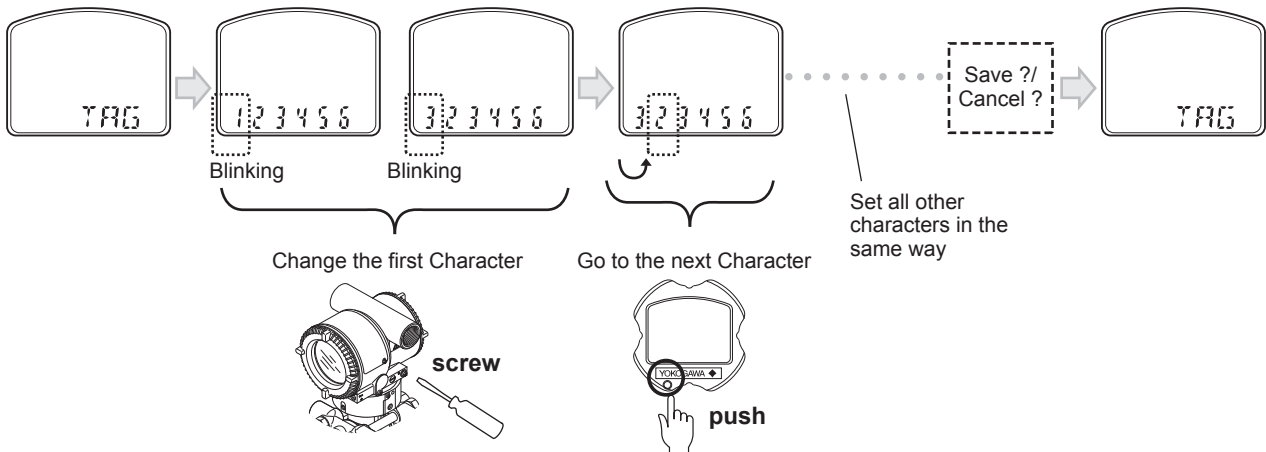

F0612.ai

6.6.6 Pressure Unit Configuration

Pressure unit for the below table can be changed as below. By turning the zero-adjustment screw, user can scroll between the various available pressure units.

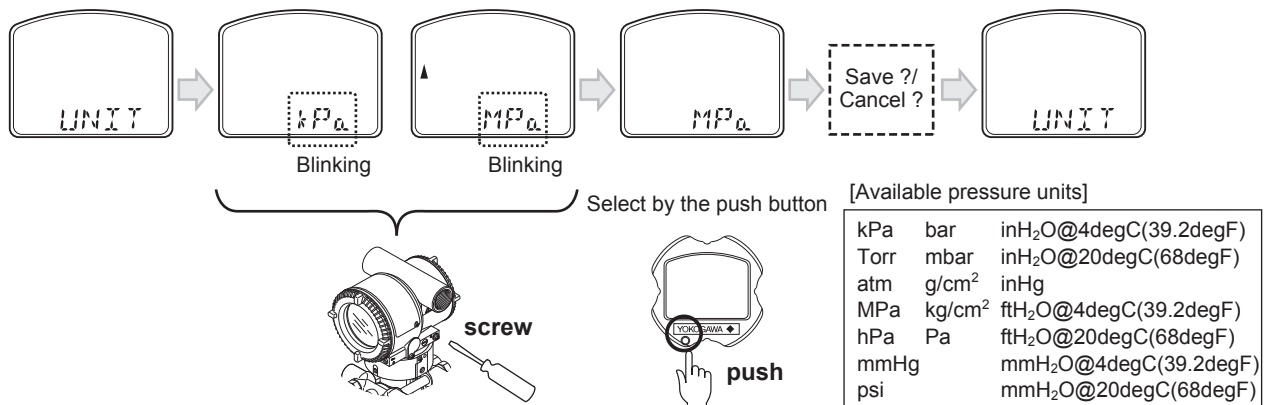

F0613.ai

6.6.7 Pressure LRV/URV Configuration

Pressure LRV and URV can be set. The number for each digit is changed by turning the zero-adjustment screw and set by pressing the push button. Please refer to 6.6.8 Damping Time Constant Configuration for how to change the numerical value.

When the setting is out of the limit, an alarm will be generated.

6.6.8 Damping Time Constant Configuration

The damping time constant for the amplifier assembly can be set. Quick Response Parameter is automatically set to ON when the damping time constant is set to less than 0.5 seconds. Damping time constant is rounded off to two decimal places.

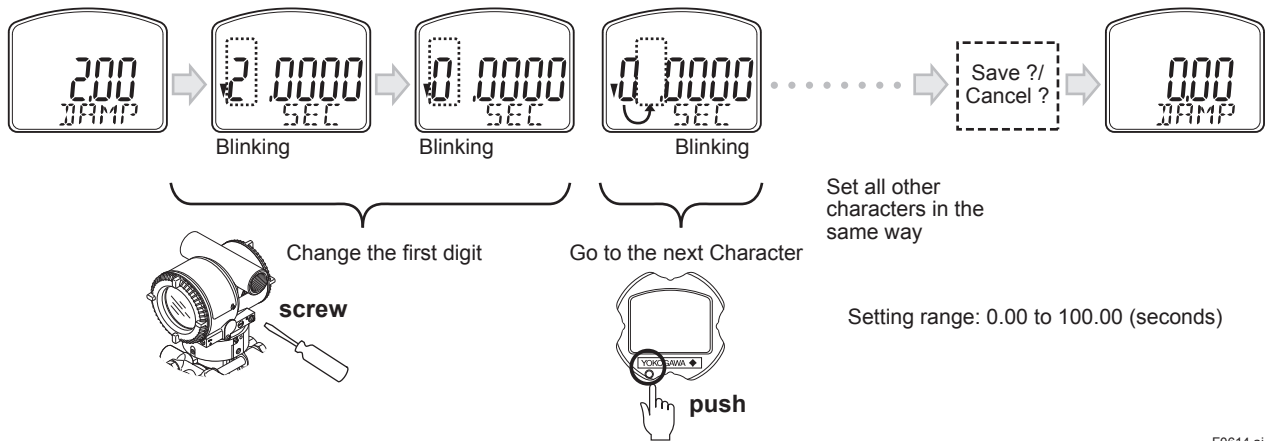

6.6.9 Output Mode Configuration

Pressure Output Mode (Linear or Sq root) can be selected by turning the zero-adjustment screw. Please refer to 6.6.6 Pressure Unit Configuration for how to select and set the enumerated value.

6.6.10 Display Out 1 Configuration

Display Out1 can be selected by turning the zero-adjustment screw. Please refer to 6.6.6 Pressure Unit Configuration for how to select and set the enumerated value.

6.6.11 Re-range by applying actual pressure (LRV/URV).

This feature allows the lower and upper range values to be setup with the actual input applied.

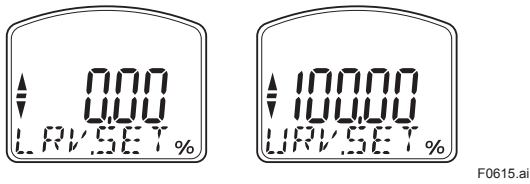

Follow the procedure below to change the LRV and URV settings.

[Example]

Rerange LRV to 0 and URV to 3 MPa.

- 1) Connect the transmitter and apparatus as shown in Figure 7.1 and warm it up for at least five minutes.
- 2) Press the push-button. The integral indicator then displays “LRV.SET.”
- 3) Apply a pressure of 0 kPa (atmospheric pressure) to the transmitter. (Note 1)
- 4) Turn the zero-adjustment screw in the desired direction. The integral indicator displays the output signal in %. (Note 2)
- 5) Adjust the output signal to 0% (1 V DC) by rotating the zero-adjustment screw. Press the push button to save the value. Doing so completes the LRV setting. (Note 3)
- 6) Press the push-button. The integral indicator then displays “URV.SET.”
- 7) Apply a pressure of 3 MPa to the transmitter. (Note 1)
- 8) Turn the zero-adjustment screw in the desired direction. The integral indicator displays the output signal in %. (Note 2)
- 9) Adjust the output signal to 100% (5 V DC) by rotating the zero-adjustment screw. Press the button to save the value. Doing so completes the URV setting.
- 10) Press the push-button. The transmitter then switches back to the normal operation mode with the measurement range of 0 to 3 MPa.

- Note 1: Wait until the pressure inside the pressure-detector section has stabilized before proceeding to the next step.
- Note 2: If the pressure applied to the transmitter exceeds the previous LRV (or URV), the integral indicator may display error number “AL.30” (In this case, the output signal percent and “AL.30” are displayed alternately every two seconds). Although “AL.30” is displayed, you may proceed to the next step. However, should any other error number be displayed, take the appropriate measure in reference to, “Errors and Countermeasures” in each communication manual.
- Note 3: Changing the lower range value (LRV) also automatically changes the upper range value (URV), keeping the span constant. New URV=previous URV+(new LRV–previous LRV)

6.6.12 Device Information Display

Model name, communication protocol, device revision and software revision are displayed repeatedly.

6.6.13 Save or Cancel

At the end of each parameter setting, select “Save” or “Cancel” by the zero-adjustment screw and press the push button to save or cancel the configuration.

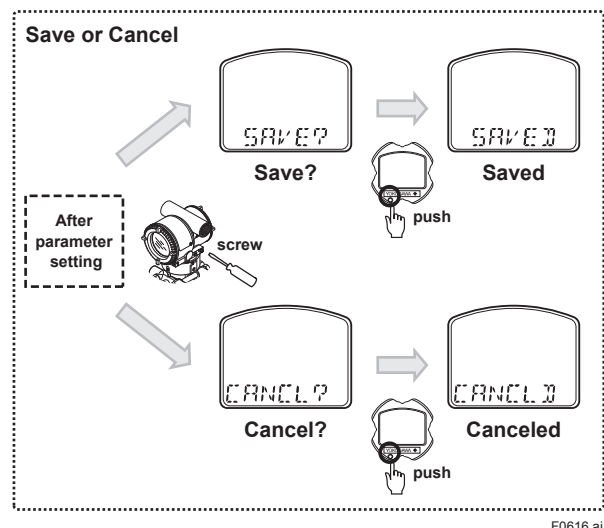

F0616.ai

6.6.14 Abort Configuration

6.6.14.1 Abort Configuration (Menu)

Hold down the push button for over 2 seconds to exit the Local Parameter Setting mode.

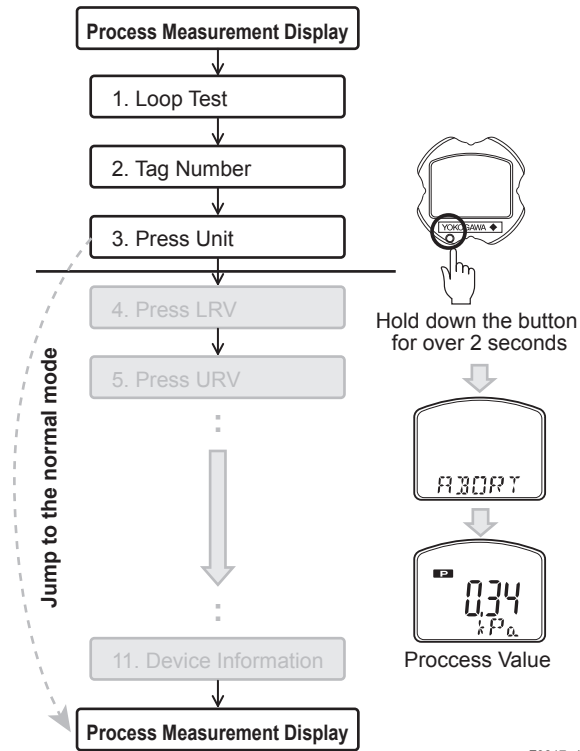

F0617.ai

6.6.14.2 Abort Configuration (Parameter)

To exit the configuration while editing the value, hold down the button for over 2 seconds and select "Save" or "Cancel."

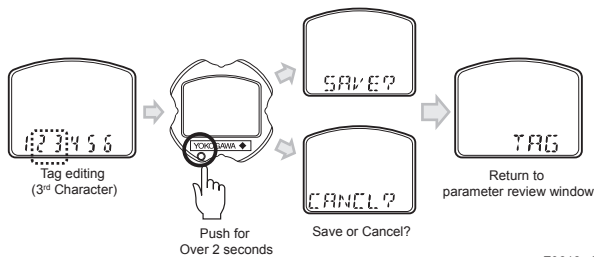

F0618.ai

6.6.15 Local Parameter Setting Lock

To disable parameter changes by the Local Parameter Setting there are three different ways.

	Locked features
Communication Parameter Ext SW =disable (EXT ZERO ADJ = disable)	<ul style="list-style-type: none"> External Zero Adjustment Local Parameter Setting
Communication Parameter Write Protect = On (WRT PROTECT = Yes)	<ul style="list-style-type: none"> Local Parameter Setting All Communication Parameters *
Hardware write protection switch on CPU assembly = D (Disable)	<ul style="list-style-type: none"> Local Parameter Setting All Communication Parameters *

*External Zero Adjustment is unlocked.

The above parameter setting is carried out by using field communicator or DTM. See the user's manual IM 01C25T (HART/BRAIN) for the setting procedure.

Reviewing local parameter setting by push button on the integral indicator is available at any time even when the Local Parameter Setting is locked.

6.6.16 Others

- Difference between BRAIN and HART

	HART	BRAIN
Tag Number	Up to 8 characters can be set	Up to 16 characters can be set
Output Mode (Linear/Sq root)	"TRNS.FC" shown on the integral indicator	"OUT.MOD" shown on the integral indicator

- The degree of adjustment depends on the speed of turning the adjustment screw. Turn the screw slowly for fine tuning and turn the screw fast for coarse tuning.

7. Maintenance

7.1 Overview



WARNING

Since the accumulated process fluid may be toxic or otherwise harmful, take appropriate care to avoid contact with the body or inhalation of vapors when draining condensate or venting gas from the transmitter pressure-detector section and even after dismounting the instrument from the process line for maintenance.

Maintenance of the transmitter is easy due to its modular construction. This chapter describes the procedures for calibration, adjustment, and the disassembly and reassembly procedures required for component replacement.

Transmitters are precision instruments. Please carefully and thoroughly read the following sections for information on how to properly handle them while performing maintenance.



IMPORTANT

- As a rule, maintenance of this transmitter should be done in a shop that has all the necessary tools.
- The CPU assembly contains sensitive parts that can be damaged by static electricity. Take precautions such as using a grounded wrist strap when handling electronic parts or touching the board circuit patterns. Also be sure to place the removed CPU assembly into a bag with an antistatic coating.

7.2 Calibration Instruments Selection

Table 7.1 lists the instruments that can be used to calibrate a transmitter. When selecting an instrument, consider the required accuracy level. Exercise care when handling these instruments to ensure they maintain the specified accuracy.

7.3 Calibration

Use the procedure below to check instrument operation and accuracy during periodic maintenance or troubleshooting.

- 1) Connect the instruments as shown in figure 7.1 and warm up the instruments for at least five minutes.



IMPORTANT

- To adjust the transmitter for highest accuracy, make adjustments with the power supply voltage and load resistance including leadwire resistances set close to the conditions under which the transmitter is installed. In addition, place the process connections of both high and low pressure side on the same level.
 - If the measurement range 0% point is 0 kPa or shifted in the positive direction (suppressed zero), the reference pressure should be applied as shown in the figure. If the measurement range 0% point is shifted in the negative direction (elevated zero), the reference pressure should be applied using a vacuum pump.
- 2) Apply reference pressures of 0%, 50%, and 100% of the measurement range to the transmitter. Calculate the errors (differences between digital voltmeter readings and reference pressures) as the pressure is increased from 0% to 100% and is decreased from 100% to 0%, and confirm that the errors are within the required accuracy.

Table 7.1 Instruments Required for Calibration

Name	Yokogawa-recommended Instrument	Remarks
Power supply	Model SDBT or SDBS distributor	4 to 20 mA DC signal
Load resistor	Model 2792 standard resistor [250 Ω ±0.005%, 3 W] Load adjustment resistor [100 Ω ±1%, 1 W]	
Voltmeter	Model 2501 A digital multimeter Accuracy (10V DC range): ±(0.002% of rdg + 1 dgt)	
Digital manometer	Model MT220 precision digital manometer 1) For 10 kPa class Accuracy: ±(0.015% of rdg + 0.015% of F.S.) for 0 to 10 kPa ±(0.2% of rdg + 0.1% of F.S.) for -10 to 0 kPa 2) For 130 kPa class Accuracy: ±0.02% of rdg for 25 to 130 kPa ±5digits for 0 to 25 kPa ±(0.2% of rdg + 0.1% of F.S.) for -80 to 0 kPa 3) For 700 kPa class Accuracy: ±(0.02% of rdg + 3digits) for 100 to 700 kPa ±5 digits for 0 to 100 kPa ±(0.2% of rdg + 0.1% of F.S.) for -80 to 0 kPa 4) For 3000 kPa class Accuracy: ±(0.02% of rdg + 10 digits) for 0 to 3000 kPa ±(0.2% of rdg + 0.1% of F.S.) for -80 to 0 kPa 5) For 130 kPa abs class Accuracy: ±(0.03% of rdg + 6 digits) for 0 to 130 kPa abs	Select a manometer having a pressure range close to that of the transmitter.
Pressure generator	Model 7674 pneumatic pressure standard for 200 kPa {2 kgf/cm ² }, 25 kPa {2500 mmH ₂ O} Accuracy: ±0.05% of F.S. Dead weight gauge tester 25 kPa {2500 mmH ₂ O} Accuracy: ±0.03% of setting	Requires air pressure supply. Select the one having a pressure range close to that of the transmitter.
Pressure source	Model 6919 pressure regulator (pressure pump) Pressure range: 0 to 133 kPa {1000 mmHg}	Prepare the vacuum pump for negative pressure ranges.

Note: The above table contains the instruments capable of performing calibration to the 0.2% level. Since special maintenance and management procedures involving traceability of each instrument to higher-level standards are required for calibration to the 0.1% or higher level, there may be difficulties in calibration to this level in the field. For calibration to the 0.1% level, contact Yokogawa representatives from which the instrument was purchased or the nearest Yokogawa office.

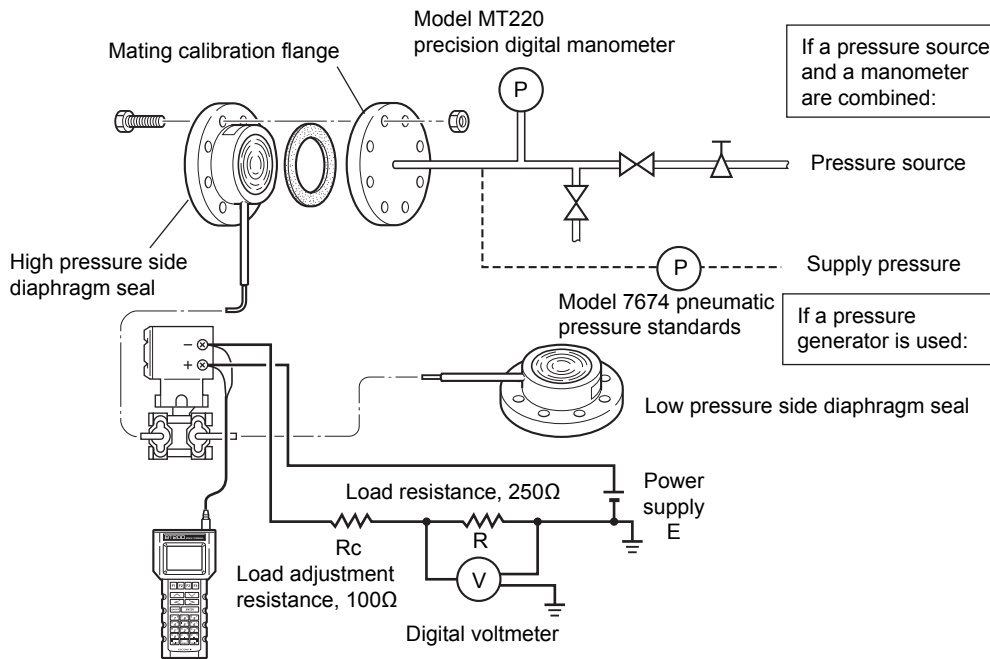

F0701.ai

Figure 7.1 Instrument Connections (4 to 20mA output)

7.4 Disassembly and Reassembly

This section describes procedures for disassembly and reassembly for maintenance and component replacement.

Always turn OFF power and shut off and release pressures before disassembly. Use proper tools for all operations. Table 7.2 shows the tools required.

Table 7.2 Tools for Disassembly and Reassembly

Tool	Quantity	Remarks
Phillips screwdriver	1	JIS B4633, No. 2
Slotted screwdriver	1	
Allen wrenches	3	JIS B4648 One each, nominal 3, 4 and 2.5 mm Allen wrenches
Wrench	1	Width across flats, 17 mm
Torque wrench	1	
Adjustable wrench	1	
Socket wrench	1	Width across flats, 16 mm
Socket driver	1	Width across flats, 5.5 mm
Tweezers	1	



CAUTION

Precautions for ATEX Flameproof Type Transmitters

- Flameproof type transmitters must be, as a rule, removed to a non-hazardous area for maintenance and be disassembled and reassembled to the original state.
- On the flameproof type transmitters the two covers are locked, each by an Allen head bolt (shrouding bolt). When a shrouding bolt is driven clockwise by an Allen wrench, it is going in and cover lock is released, and then the cover can be opened.
When a cover is closed it should be locked by a shrouding bolt without fail. Tighten the shrouding bolt to a torque of 0.7 N·m {7 kgf·cm}.

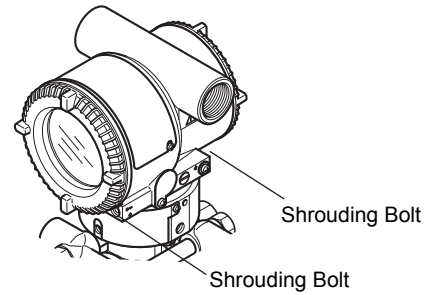

F0702.ai

Figure 7.2 Shrouding Bolts

7.4.1 Replacing the Integral Indicator



CAUTION

Cautions for Explosion-proof/Flameproof Type Transmitters

Users are prohibited by law from modifying the construction of a explosion-proof/Flameproof type transmitter. This would invalidate the agency approval for the use of the transmitter in a rated area.

It follows that the user is prohibited from using a explosion-proof/Flameproof type transmitter with its integral indicator removed, or from adding an integral indicator to a transmitter. If such modification is absolutely required, contact Yokogawa.

This subsection describes the procedure for replacing an integral indicator. (See figure 7.3)

■ Removing the Integral Indicator

- Remove the cover.
- While supporting the integral indicator with one hand, loosen its two mounting screws.
- Dismount the LCD board assembly from the CPU assembly.
When doing this, carefully pull the LCD board assembly straight forward so as not to damage the connector pins between it and the CPU assembly.

■ Attaching the Integral Indicator

- Align both the LCD board assembly and CPU assembly connectors and engage them.
- Insert and tighten the two mounting screws.
- Replace the cover.

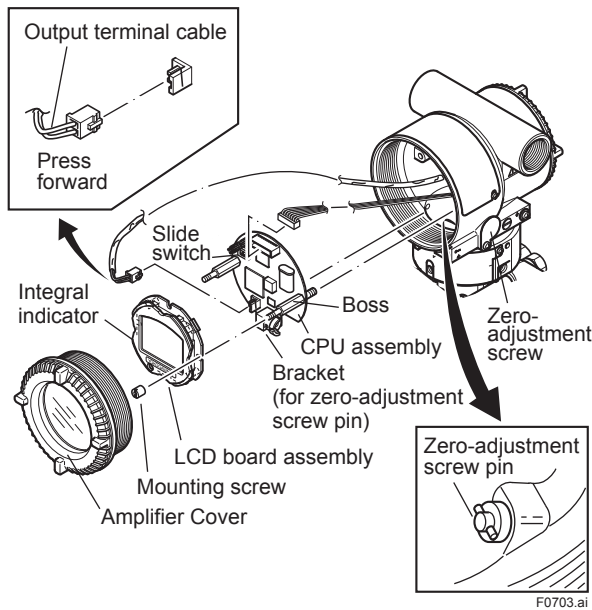

Figure 7.3 Removing and Attaching LCD Board Assembly and CPU Assembly

7.4.2 Replacing the CPU Board Assembly

This subsection describes the procedure for replacing the CPU assembly. (See figure 7.3)

■ Removing the CPU Assembly

- 1) Remove the cover. If an integral indicator is mounted, refer to subsection 7.4.1 and remove the indicator.
- 2) Turn the zero-adjustment screw to the position (where the screw head slot is horizontal) as shown in figure 7.3.
- 3) Disconnect the output terminal cable (cable with brown connector at the end). When doing this, lightly press the side of the CPU assembly connector and pull the cable connector to disengage.
- 4) Use a socket driver (width across flats, 5.5mm) to loosen the two bosses.
- 5) Carefully pull the CPU assembly straight forward to remove it.
- 6) Disconnect the flat cable (cable with white connector at the end) that connects the CPU assembly and the capsule.



NOTE

Be careful not to apply excessive force to the CPU assembly when removing it.

■ Mounting the CPU Assembly

- 1) Connect the flat cable (with white connector) between the CPU assembly and the capsule.
- 2) Connect the output terminal cable (with brown connector).



NOTE

Make certain that the cables do not get pinched between the case and the edge of the CPU assembly.

- 3) Align and engage the zero-adjustment screw pin with the groove on the bracket on the CPU assembly. Then insert the CPU board assembly straight onto the post in the amplifier case.
- 4) Tighten the two bosses. If the transmitter is equipped with an integral indicator, refer to subsection 7.4.1 to mount the indicator.



NOTE

Confirm that the zero-adjustment screw pin is placed properly in the groove on the bracket prior to tightening the two bosses. If it is not, the zero-adjustment mechanism will be damaged.

- 5) Replace the cover.

7.5 Troubleshooting

If any abnormality appears in the measured values, use the troubleshooting flow chart below to isolate and remedy the problem. Since some problems have complex causes, these flow charts may not identify all. If you have difficulty isolating or correcting a problem, contact Yokogawa service personnel.

7.5.1 Basic Troubleshooting

First determine whether the process variable is actually abnormal or a problem exists in the measurement system.

If the problem is in the measurement system, isolate the problem and decide what corrective action to take.

This transmitter is equipped with a self-diagnostic function which will be useful in troubleshooting, and the transmitter equipped with an integral indicator will show an alarm code as a result of self-diagnosis.

See subsection 7.5.3 for the list of alarms. See also each communication manual.

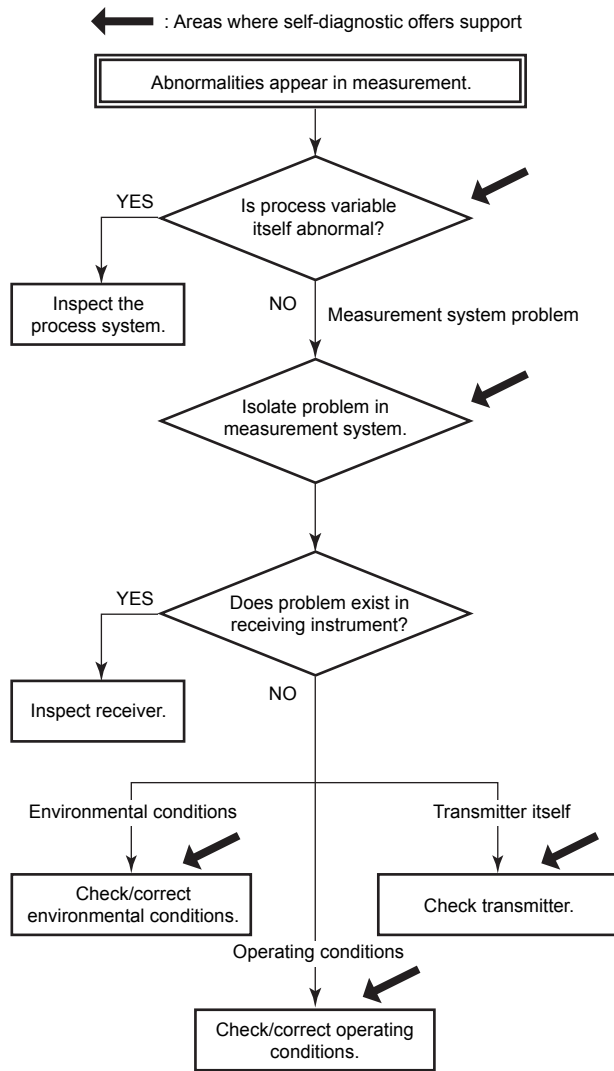

F0704.ai

Figure 7.5 Basic Flow and Self-Diagnostics

7.5.2 Troubleshooting Flowcharts

The following sorts of symptoms indicate that the transmitter may not be operating properly.
 Example : • There is no output signal.
 • Output signal does not change even though process variable is known to be varying.
 • Output value is inconsistent with value inferred for process variable.

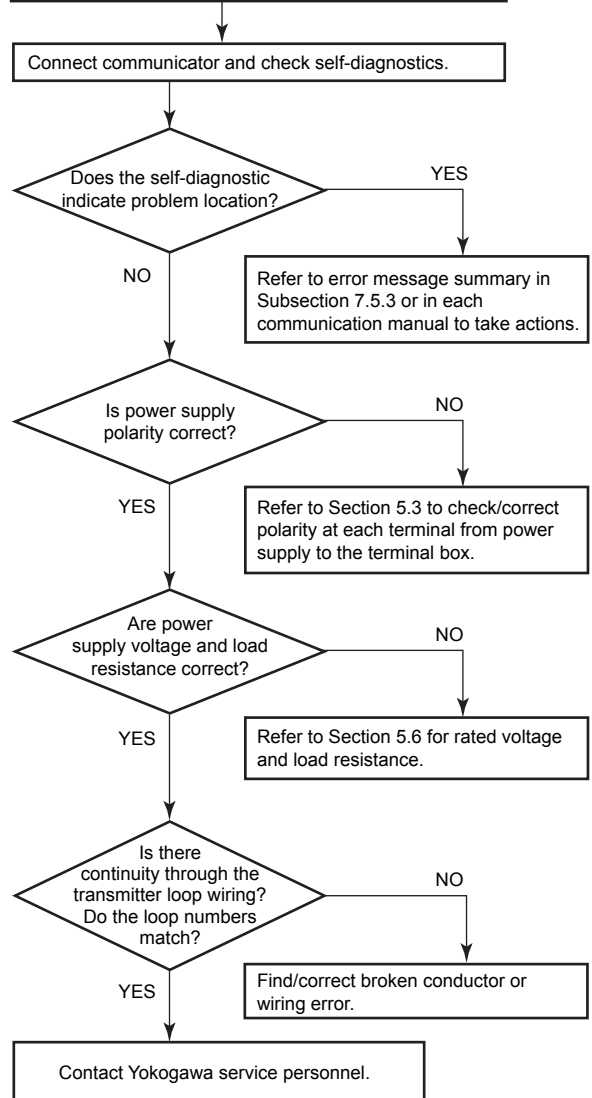

F0705.ai

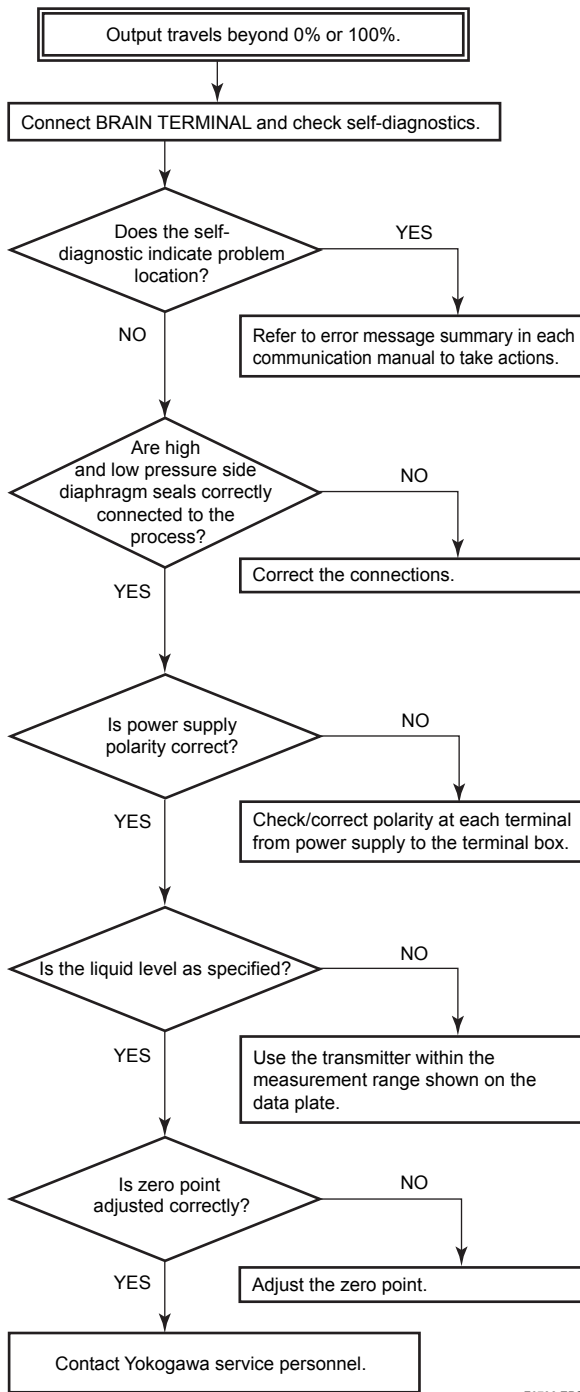

F0706.EPS

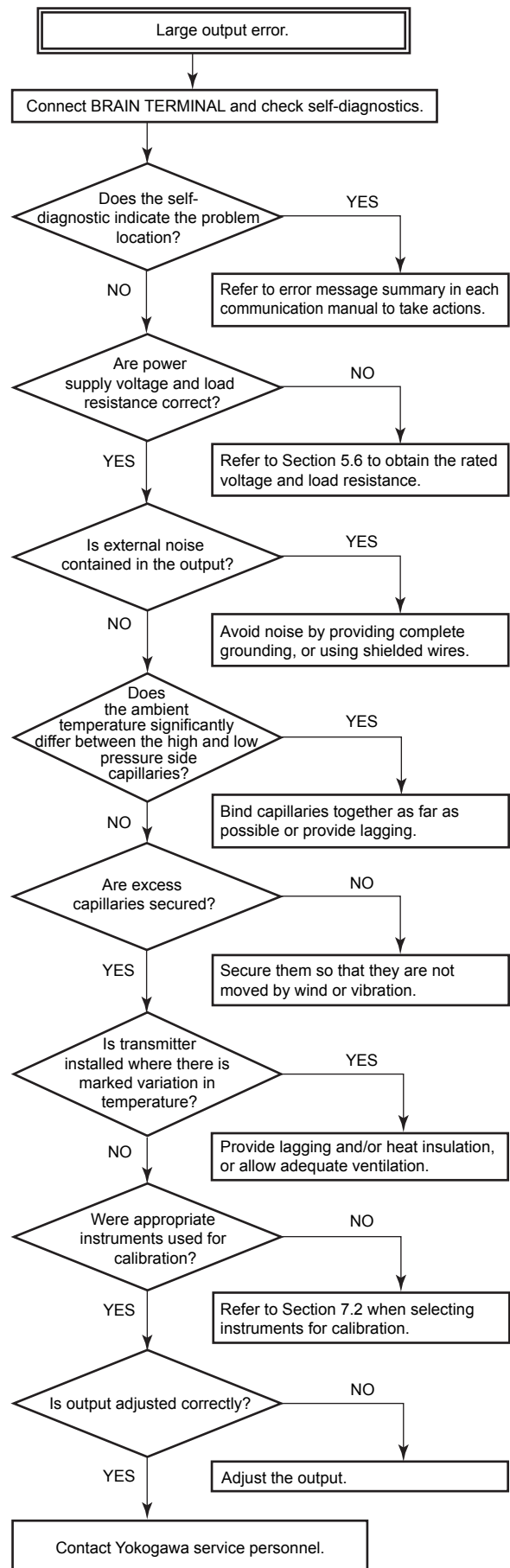

F0707.ai

7.5.3 Alarms and Countermeasures

Table 7.3 Alarm Message Summary

Indicator	Cause	Output Operation during Error	Countermeasure
None			
AL. 01 CAP. ERR	Sensor problem. Capsule temperature sensor problem. Capsule EEPROM problem.	Outputs the signal (Hold, High, or Low) set with parameter.	Replace capsule when error keeps appearing even after restart.
AL. 02 AMP. ERR	Amplifier temperature sensor problem. Amplifier EEPROM problem. Amplifier problem.	Outputs the signal (Hold, High, or Low) set with parameter.	Replace amplifier.
AL. 10 PRESS	Input is outside measurement range limit of capsule.	Outputs high range limit value or low range limit value.	Check input or replace capsule when necessary. Use heat insulation or make lagging to keep temperature within range.
AL. 11 ST. PRSS	Static pressure exceeds limit.	Continues to operate and output.	
AL. 12 CAP. TMP	Capsule temperature is outside range (-50 to 130°C).		
AL. 13 AMP. TMP	Amplifier temperature is outside range (-50 to 95°C)		
AL. 30 RANGE	Output is outside upper or lower range limit value.	Outputs high range limit value or low range limit value.	Check input and range setting, and change them as needed.
AL. 31 SP. RNG	Static pressure exceeds specified range.	Continues to operate and output.	Check input.
AL. 35 *1 P. HI	Input pressure exceeds specified threshold.		
AL. 36 *1 P. LO			
AL. 37 *1 SP. HI	Input static pressure exceeds specified threshold.		
AL. 38 *1 SP. LO			
AL. 39 *1 TMP. HI	Detected temperature exceeds specified threshold.		
AL. 40 *1 TMP. LO			
AL. 50 P. LRV	Specified value is outside of setting range.	Holds output immediately before error occurred.	Check setting and change them as needed.
AL. 51 P. URV			
AL. 52 P. SPN			
AL. 53 P. ADJ		Continues to operate and output.	Check input.
AL. 54 SP. RNG		Continues to operate and output holding static pressure in %.	Check setting and change them as needed.
AL. 55 SP. ADJ		Continues to operate and output.	Check input.
AL. 60 SC. CFG		Specified values or settings to define signal characterizer function do not satisfy the condition.	
AL. 79 OV. DISP	Displayed value exceeds limit.		

*1: These alarms may appear only when process alarm function is activated.

8. General Specifications

Please refer to the following General Specifications list for the specifications, model, suffix and option codes, and external dimensions of each product.

The General Specifications can be downloaded from the website of Yokogawa.

Website address: <https://www.yokogawa.com/solutions/products-platforms/field-instruments/>

■ General Specifications List

Model	Document Title	Document No.
EJX110A	Differential Pressure Transmitter	GS 01C25B01-01EN
EJX120A	Differential Pressure Transmitter	GS 01C25B03-01EN
EJX130A	Differential Pressure Transmitter	GS 01C25B04-01EN
EJX210A	Flange Mounted Differential Pressure Transmitter	GS 01C25C01-01EN
EJX310A	Absolute Pressure Transmitter	GS 01C25D01-01EN
EJX430A	Gauge Pressure Transmitter	GS 01C25E01-01EN
EJX440A	Gauge Pressure Transmitter	GS 01C25E02-01EN
EJX510A, EJX530A	Absolute and Gauge Pressure Transmitters	GS 01C25F01-01EN
EJX610A, EJX630A	Absolute and Gauge Pressure Transmitters	GS 01C25F05-01EN
EJX118A	Diaphragm Sealed Differential Pressure Transmitter	GS 01C25H01-01EN
EJX118A	Diaphragm Sealed Differential Pressure Transmitter (Inner Diaphragm type)	GS 01C25H01-11EN
EJX438A	Diaphragm Sealed Gauge Pressure Transmitter	GS 01C25J03-01EN
EJX438A	Diaphragm Sealed Gauge Pressure Transmitter (Inner Diaphragm type)	GS 01C25J03-11EN
EJX115A	Low Flow Transmitter	GS 01C25K01-01EN
EJX910A	Multivariable Transmitter	GS 01C25R01-01EN
EJX930A	Multivariable Transmitter	GS 01C25R04-01EN
EJXC50A, EJXC40A, EJAC50E, C20FE, C20FW, C10FR, EJXC80A, EJAC80E, C81FA, C82FA, C81FD, C82FD, C30SW, C30SE, C80FW, C80FE, EJXC81A, EJAC81E, C70SE, C70SW	Diaphragm Seal System	GS 01C25W01-01EN
EJXC40A	Digital Remote Sensor	GS 01C25W05-01EN
EJX110A, EJX130A	Differential Pressure Transmitter High Damping Capsule (Option Code: /HD)	GS 01C25V01-01EN
EJX110A	Differential Pressure Transmitters High Damping Capsule (General) (Option Code: /HD2)	GS 01C25V02-01EN
EJX-A, EJA-E	Explosion Protected Type and Marine Certificate Type	GS 01C25A20-01EN
EJA110E	Differential Pressure Transmitter	GS 01C31B01-01EN
EJA120E	Differential Pressure Transmitter	GS 01C31B03-01EN
EJA130E	Differential Pressure Transmitter	GS 01C31B04-01EN
EJA210E	Flange Mounted Differential Pressure Transmitter	GS 01C31C01-01EN
EJA310E	Absolute Pressure Transmitter	GS 01C31D01-01EN
EJA430E	Gauge Pressure Transmitter	GS 01C31E01-01EN
EJA440E	Gauge Pressure Transmitter	GS 01C31E02-01EN
EJA510E, EJA530E	Absolute Pressure Transmitter and Gauge Pressure Transmitter	GS 01C31F01-01EN
EJA118E	Diaphragm Sealed Differential Pressure Transmitter	GS 01C31H01-01EN
EJA118E	Diaphragm Sealed Differential Pressure Transmitter (Inner Diaphragm type)	GS 01C31H01-11EN
EJA438E	Diaphragm Sealed Gauge Pressure Transmitter	GS 01C31J03-01EN
EJA438E	Diaphragm Sealed Gauge Pressure Transmitter (Inner Diaphragm type)	GS 01C31J03-11EN
EJA115E	Low Flow Transmitter	GS 01C31K01-01EN
EJAC60E, EJA560E	Hygienic Adapter System (Fluidless Type) Hygienic Gauge Pressure Transmitter (Fluidless Type)	GS 01C31Y01-01EN
EJA110E, EJA130E	Differential Pressure Transmitter High Damping Capsule (Option Code: /HD)	GS 01C31V01-01EN
EJA110E	Differential Pressure Transmitters High Damping Capsule (General) (Option Code: /HD2)	GS 01C31V02-01EN

If you cannot find it on our website, please contact YOKOGAWA office.

Revision Information

- Title : Diaphragm Sealed Differential Pressure and Pressure Transmitters
EJ□118□ and EJ□438□
- Manual No. : IM 01C25H01-01E

Edition	Date	Page	Revised Item
1st	Oct. 2004	—	New publication
10th	June 2014	1-2 2-6 2-13 5-1 to 5-4 5-1 5-2, 6-1 6-4 to 6-9 8-20	1. • Add note for symbols. 2.9.2 • Revise category for CSA Nonincendive. 2.12 • Update safety requirement standard. 5. • Revise drawings and symbols for terminal. 5.3.1 • Add note for power supply. Add note for BRAIN communication. 6.6 • Add local parameter setting function. 8.4 • Change terminal drawing.
11th	Oct. 2014	2-3 2-5 2-7, 2-8 2-9 to 2-10 2-13 to 2-14 2-14 5-1 5-2 5-3 to 5-4 5-5 6-6 6-7 6-8 6-9 7-7 8-1, 8-4 8-4 8-7, 8-8 8-15 8-21	2.8 • Add information for 1 to 5 V output. 2.9.1 • Add information for 1 to 5 V output. 2.9.2 • Add information for 1 to 5 V output. 2.9.3 • Add information for 1 to 5 V output. 2.9.4 • Add EPL code. Revise applicable standard. Add information for 1 to 5 V output. Add note for electro static charge. Add electrical connection. 2.10 • Add standard for PROFIBUS. 5.3 • Add Figure 5.1 Terminal. 5.3.3 • Add information for 1 to 5 V output. 5.4 • Add information for 1 to 5 V output. 5.6 • Add applicability. 6.6.1 • Add "10.Device information" in Figure 6.7. 6.6.3 • Add note in the figure. 6.6 • Add 6.6.6 Pressure LRV/URV Configuration. 6.6 • Add 6.6.8 Output Mode Configuration and 6.6.9 Display Out 1 Configuration. 7.5.3 • Correct AL31 output operation. 8.1 • Add information for 1 to 5 V output. • Add EMC standard for PROFIBUS and EMI specification. 8.2 • Add output signal code Q 8.3 • Revise the description for SU2 and SF2. 8.4 • Add information for 1 to 5 V output.
12th	July 2015	1-2 1-3 2-1 2-5, 2-7, 2-9, 2-14 2-6, 2-7 2-12 2-12 to 2-13 2-16 2-16 6-5 6-6 8-4 8-9 to 8-14 8-15	• Add trademark statement. 1.1 • Add (g) and (h). 2.1 • Replace Figure 2.2. • Delete /V1F. 2.9.2 • Add "No.61010-2-030." 2.9.3 (6) • Replace nameplate. 2.9.4 • Add SU21. Add a and b. 2.10 • Change the note for EN 61326-2-5. 2.12 • Add C22.2 standards. 6.6.1 • Delete note for -Q in Figure 6.7. 6.6.3 • Change note in the figure. 8.1 • Revise descriptions for EMC conformity standards. 8.2 • Delete #. 8.3 • Add SU21.

Edition	Date	Page	Revised Item
13th	Nov. 2019	Toc-3, 1-1 1-1 1-4 2-3 2-4 to 2-15 2-5 2-16 4-5 5-1 5-5 6-3 6-7 6-8 6-9 6-12 8-1 to 8-21	<ul style="list-style-type: none"> • Change the description for using the transmitters in Safety Instrumented Systems (SIS) application. • Add style code S2 for EJA118E and EJA438E. • Add a note for Regarding This Manual. • Add (i) Control of Pollution Caused by the product. • Change the value of dielectric strength test: 10mA→25mA • 2.9 revised the description. • Changed the applicable standard for FM Explosionproof Type. • Deleted (for use in industrial locations) • Add CAUTION. • Change the description of (1) and (2). • Add 2.12 EU RoHS Directive. • Change the applicable standard. • Delete Altitude of installation site. • Change the description. • Add WARNING. • 5.1 delete silicone group. • 5.4 delete the description about non-hardening sealant for flameproof type. • Add note. • Add Loop test description, figure and notes. • Add Loop test description and figure. • Add 6.6.4 Loop Test Configuration. • Change the figure. • Delete the description for general specifications and add the General Specifications list.
14th	Apr. 2020	2-6 to 2-9 2-10, 2-11, 2-13 2-16 2-17	<ul style="list-style-type: none"> 2.9.2 • Updated the description for CSA Certification. 2.9.3 • Updated the description for ATEX Certification. 2.10 • Added some information for EMC Conformity Standards. 2.13 • Added (3) and (4).
15th	July 2021	2-9 2-10 2-11 2-12 1-13 2-13 2-17	<ul style="list-style-type: none"> 2.9.3 a • Update all the descriptions. 2.9.3 b • Update marking code. 2.9.3 c • Update all the descriptions. 2.9.3 (2) • Delete screw size and marking. Delete WARNING. 2.9.3 (3) • Update tag plates. 2.9.4 a • Update all the descriptions. 2.12 • Change EU RoHS Directive.